

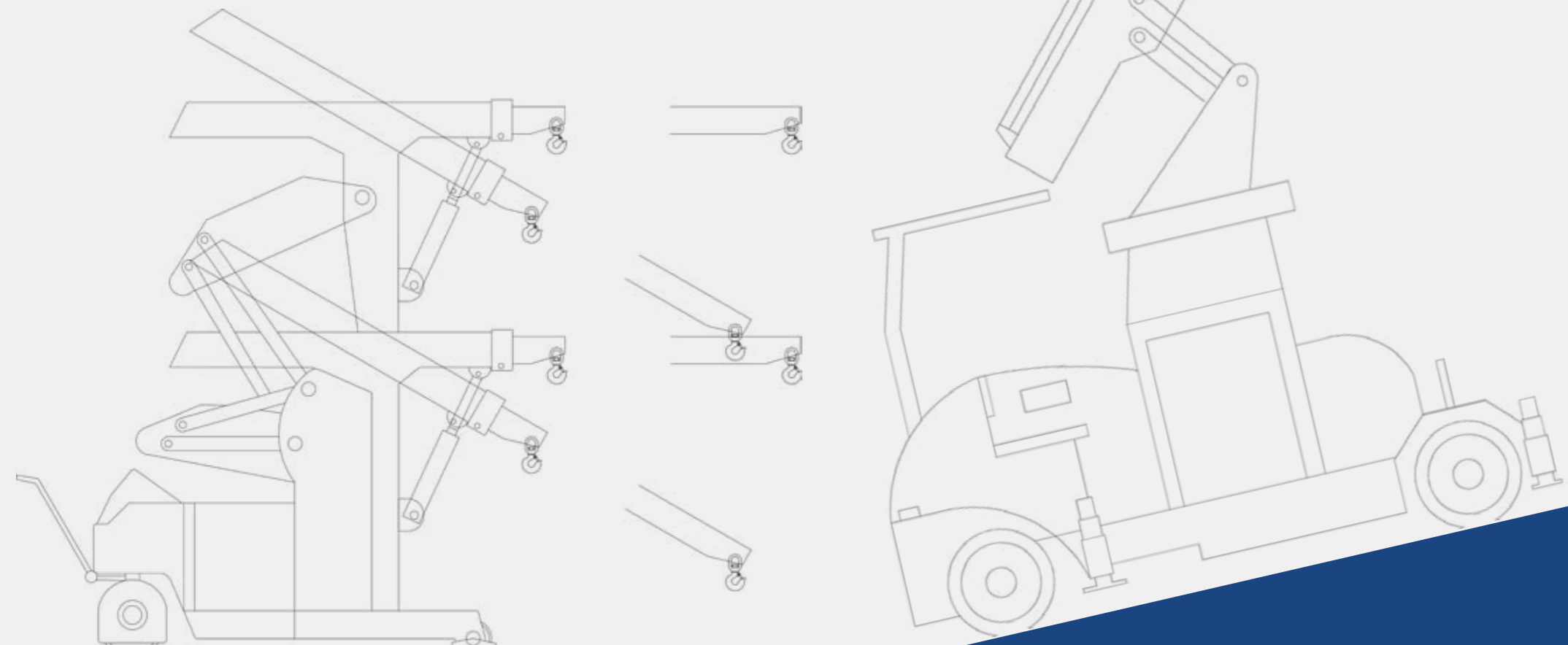

GRUNIVERPAL S.r.l
 Via Provinciale Verzuolo, 2,
 12026 PIASCO [CN] - Italy
 Phone: +39 0175 79301
 Fax: +39 0175 797948
 web: www.gruniverpal.com

THE TECHNOLOGY OF THE FUTURE.
 SINCE 1954.



CRANES & LIFTING EQUIPMENT



CRANES FOR PLASTIC INJECTION MOULDING
MOBILE CRANES
 CRANES FOR TYRE MOULDING



GT•CRANES QUALITY, CERTIFIED QUALITY.



GT•CRANES WORLDWIDE
OUR DISTRIBUTION NETWORK.



18000
CRANES
DELIVERED

7000
HAPPY
CLIENTS

750
REGISTERED
PATENTS

62
COVERED
COUNTRY

65
YEARS OF
EXPERIENCE

GT•CRANES. THE BEST RANGE OF MOBILE CRANES AND LIFTING EQUIPMENT.

PLASTIC INJECTION MOULDING

GB 500_TR STANDARD / GB 500_TR VERTICAL.....	4
GB 750_TR STANDARD / GB 750_TR VERTICAL.....	6
MINIDREL 20S_HG / MINIDREL 20S_STD.....	8
MINIDREL 20SL_HG / MINIDREL 20SL_STD.....	10
MINIDREL 25S_HG / MINIDREL 40S_HG.....	12
MINIDREL 50S_HG / MINIDREL 60S_HG.....	14
MINIDREL 75S_HG / MINIDREL 100S_HG.....	16
MINIDREL 120S_HG / MINIDREL 150S_HG.....	18
TRANSIDREL 300B / 350B / 500B	20

MOBILE CRANES

MINIDREL 30B_STD / MINIDREL 30B_CMP / MINIDREL 30B_ADW.....	22
MINIDREL 50B_WVR / MINIDREL 50B_R.....	24
MINIDREL 75B_TRS / MINIDREL 75B_R.....	26
MINIDREL 90B_R / MINIDREL 90B_MSR.....	28
MINIDREL 125B_TRS / MINIDREL 125B_R / MINIDREL 150B_R	30
MINIDREL 250B_TRS	32

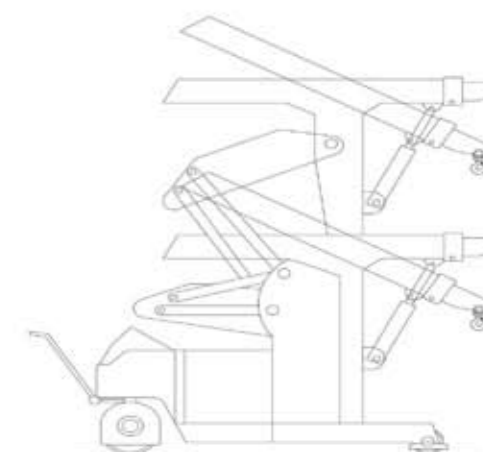
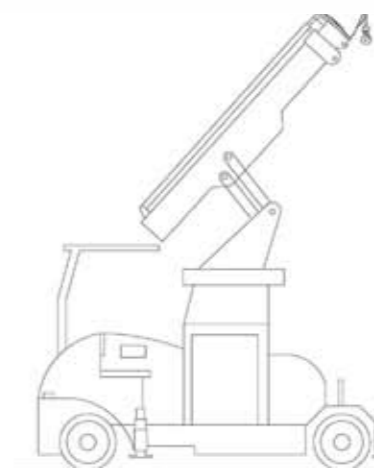
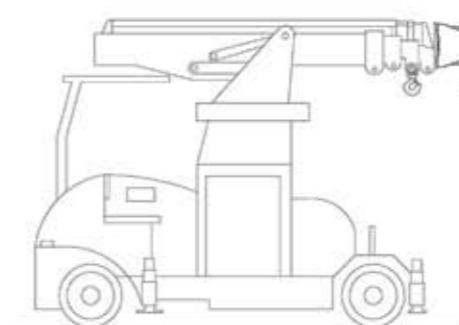
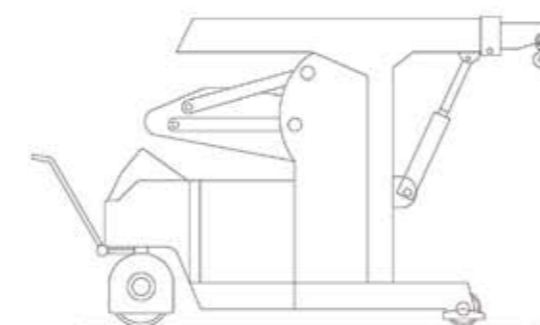

CRANES FOR TYRE MOULDING

GB 100 / GB 150.....	34
GB 300_TR STANDARD / GB 500_TR STANDARD.....	36
MINIDREL 20SL_AZR.....	38
MINIDREL 40S_ARR / MINIDREL 60S_ARR.....	40
MINIDREL 75S_ARR / MINIDREL 100S_ARR.....	42
MINIDREL 50B_SRR / MINIDREL 50B_MSR.....	44

SPECIAL LIFTING EQUIPMENT

SPECIAL LIFTING EQUIPMENT.....	46
--------------------------------	----

OPTIONAL

OPTIONAL FOR MOBILE CRANES.....	48
---------------------------------	----



GT CRANES GRUNIVERPAL, THE TECHNOLOGY OF THE FUTURE, SINCE 1954.



LIFTING EQUIPMENT. SINCE 1954.

LIFTING EQUIPMENT. SINCE 1954.

EN

IT

DE

ES

FR

PT

GT cranes (Gruniverpal Tranchero) was founded in 1954. The company, specialized in the production of electrohydraulic lifting equipment for workshops and industrial applications, becomes synonymous with exclusive made in Italy products that are able to anticipate sector trends. In the sixties, thanks to its record of patents and machines, GT cranes was repeatedly awarded the gold medal at the International Grand Prix of Inventions.

GT cranes (Gruniverpal Tranchero) è stata fondata nel 1954. L'azienda, specializzata nella produzione di attrezzi di sollevamento elettroidraulici per officine meccaniche e per applicazioni industriali, diventa sinonimo di *made in Italy* esclusivo che anticipa le tendenze del settore. Negli anni Sessanta, grazie al record di brevetti e di macchine, GT cranes è più volte medaglia d'oro al Gran Premio Internazionale delle Invenzioni.

GT cranes (Gruniverpal Tranchero) es wurde 1954 gegründet. Das auf die Produktion von elektrohydraulischen Hubausrüstungen für mechanische Werkstätten und industrielle Anwendungen spezialisiert ist. GT cranes wird zum Synonym des exklusiven *made in Italy*, das die Tendenzen des Sektors antizipiert. In den sechziger Jahren erhält GT cranes dank des Rekords von Patenten und Maschinen mehrmals die Goldmedaille bei der Internationalen Messe für Erfindungen.

GT cranes (Gruniverpal Tranchero) fue fundada en 1954. La empresa, especializada en la producción de herramientas electrohidráulicas para elevación destinadas a talleres mecánicos y aplicaciones industriales, se convirtió en un sinónimo de *made in Italy* exclusivo que anticipaba las tendencias del sector. Durante los años Sesenta, gracias al récord de patentes y de máquinas, GT cranes fue diversas veces medalla de oro en el Gran Premio Internacional de Invencciones.

GT cranes (Gruniverpal Tranchero) a été fondée en 1954. L'entreprise, spécialisée dans la production d'outils de levage électro-hydrauliques pour des ateliers mécaniques et pour des applications industrielles, devient synonyme de *made in Italy* exclusif qui anticipe les tendances du secteur. Dans les années Soixante, grâce au record de brevets et de machines, Gt cranes remporte à plusieurs reprises la médaille d'or au Grand Prix International des Inventions.

GT cranes (Gruniverpal Tranchero) foi fundada em 1954. A empresa, especializada na produção de equipamentos de elevação eletro hidráulicos para oficinas mecânicas e aplicações industriais, torna-se sinônimo do conceito *made in Italy* exclusivo que antecipa as tendências do sector. Nos anos 60, graças ao recorde de patentes e de máquinas, a GT cranes ganha várias vezes a medalha de ouro no Grande Prêmio Internacional das Invenções.

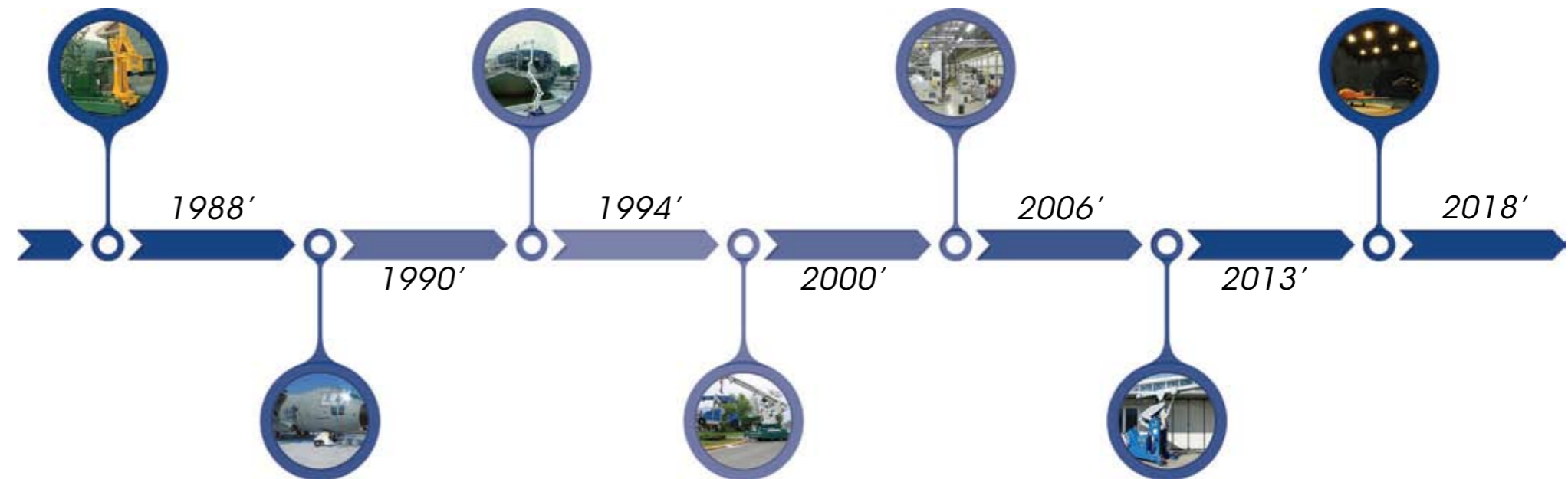
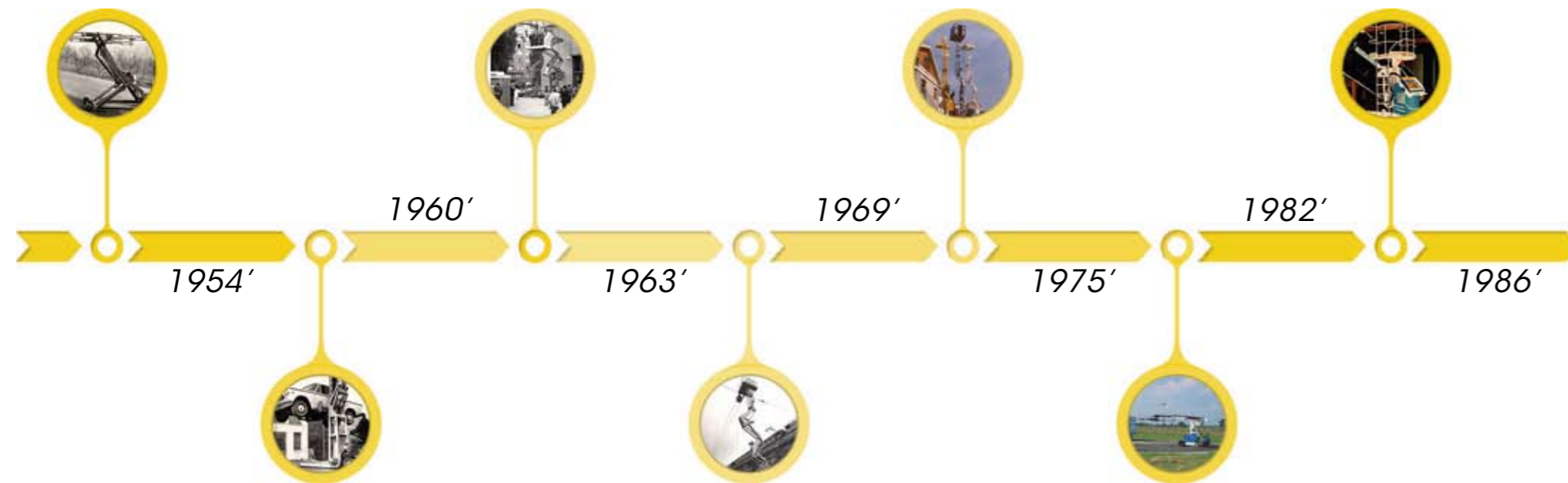

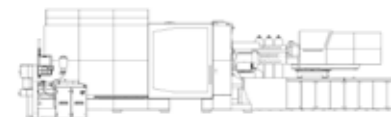

CLAMPING FORCE RANGE 50-150 T.

EN The proper solution for absolute precision positioning of press moulds during lifting operations: from plastic injection producers to aluminium foundries.

IT Gru elettriche ideali per i sollevamenti in cui si richiede una precisione assoluta di posizionamento dello stampo in pressa. Ideale per le aziende di materie plastiche e le fonderie di alluminio.

DE Industriekrane. Werkzeughandling-geräte übernommen. Sie verfügen über besonders kompakte Baumaße und sehr hohe Traglasten im Arbeitsbereich.

ES La solución ad hoc para las elevaciones en las que es necesaria una precisión absoluta en la colocación del molde en la prensa: desde empresas de materias plásticas a fundiciones de aluminio.

FR Simples à utiliser, sont la solution sur mesure pour les levages qui requièrent une précision de positionnement absolue du moule en presse: des entreprises de matières plastiques aux fonderies d'aluminium.

PT Guindastes móvel hidráulicos para operar em contextos pequenos. Guindastes autopropelidos ideais para setor das matérias plásticas ou em aplicações na manutenção industrial.

GB500_TR STANDARD

Maximum load capacity	500 kg
Standard min. hook's height from the ground	200 mm
Standard max. hook's height from the ground	3.200 mm
Possibility to extend height up to (option)	4.200 mm
Standard max. telescopic extension	1.960 mm
Capacity at standard max. telescopic extension	280 kg
Possibility to extend telescopic extension up to (option)	3.000 mm
Capacity at max.telescopic extension (point 7)	180 kg
Rotation (option)	60° - 150° -270°
Wheelbase	1.200 mm
Dimensions - length	1.550 mm
Dimensions - width	950 mm
Dimensions - height	1.600 mm
Adjustable speed from / to	From 0 to 40 m/min
Max. surmountable slope (unloaded)	8%
Max. surmountable slope (loaded)	3%
Front wheels	4 x Ø 160 x 60 mm
Wheels material	Polyurethane
Drive	REAR WHEEL
Total weight	1.350 Kg
Electric motor power	1,5 KW / 12 V.
Hardened battery (standard)	200 Ah / 12 V
Battery charger on board	110 / 240 V-50/60 Hz
Lead acid battery	-
Gel battery	•
Additional autonomy of battery	○
Proportional control on board of all movements	•
Certification to standard 2006/42 CE	•
Made in accordance (not certified) to standard UL508 A	•
Certification (issued by Third Party) to standard UL508 A	○
Drive hydraulic unit	•
Automatic braking system	•
Overloading safety system	•
Pressure safety valves on each movements	•

GB500_TR VERTICAL

Maximum load capacity	500 kg
Standard min. hook's height from the ground	950 mm
Standard max. hook's height from the ground	2.200 mm
Possibility to extend height up to (option)	-
Standard max. telescopic extension	1.960 mm
Capacity at standard max. telescopic extension	280 kg
Possibility to extend telescopic extension up to (option)	3.000 mm
Capacity at max.telescopic extension (point 7)	180 kg
Rotation (option)	60° - 150° -270°
Wheelbase	1.200 mm
Dimensions - length	1.550 mm
Dimensions - width	950 mm
Dimensions - height	1.600 mm
Adjustable speed from / to	From 0 to 40 m/min
Max. surmountable slope (unloaded)	8%
Max. surmountable slope (loaded)	3%
Front wheels	4 x Ø 160 x 60 mm
Wheels material	Polyurethane
Drive	REAR WHEEL
Total weight	1.350 Kg
Electric motor power	1,5 KW / 12 V.
Hardened battery (standard)	200 Ah / 12 V
Battery charger on board	110 / 240 V-50/60 Hz
Lead acid battery	-
Gel battery	•
Additional autonomy of battery	○
Proportional control on board of all movements	•
Certification to standard 2006/42 CE	•
Made in accordance (not certified) to standard UL508 A	•
Certification (issued by Third Party) to standard UL508 A	○
Drive hydraulic unit	•
Automatic braking system	•
Overloading safety system	•
Pressure safety valves on each movements	•



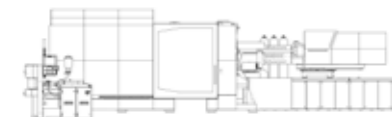

CLAMPING FORCE RANGE 50-200 T.

EN The proper solution for absolute precision positioning of press moulds during lifting operations: from plastic injection producers to aluminium foundries.

IT Gru elettriche ideali per i sollevamenti in cui si richiede una precisione assoluta di posizionamento dello stampo in pressa. Ideale per le aziende di materie plastiche e le fonderie di alluminio.

DE Industriekrane. Werkzeughandlangeräte übernommen. Sie verfügen über besonders kompakte Baumaße und sehr hohe Traglasten im Arbeitsbereich.

ES La solución ad hoc para las elevaciones en las que es necesaria una precisión absoluta en la colocación del molde en la prensa: desde empresas de materias plásticas a fundiciones de aluminio.

FR Simples à utiliser, sont la solution sur mesure pour les levages qui requièrent une précision de positionnement absolue du moule en presse: des entreprises de matières plastiques aux fonderies d'aluminium.

PT Guindastes móvel hidráulicos para operar em contextos pequenos. Guindastes autopropelidos ideais para setor das matérias plásticas ou em aplicações na manutenção industrial.

GB750_TR STANDARD

Maximum load capacity	750 kg
Standard min. hook's height from the ground	200 mm
Standard max. hook's height from the ground	3.200 mm
Possibility to extend height up to (option)	4.200 mm
Standard max. telescopic extension	1.960 mm
Capacity at standard max. telescopic extension	375 kg
Possibility to extend telescopic extension up to (option)	3.000 mm
Capacity at max.telescopic extension (point 7)	280 kg
Rotation (option)	60° - 150°
Wheelbase	1.200 mm
Dimensions - length	1.650 mm
Dimensions - width	1.200 mm
Dimensions - height	1.600 mm
Adjustable speed from / to	From 0 to 40 m/min
Max. surmountable slope (unloaded)	8%
Max. surmountable slope (loaded)	3%
Front wheels	4 x Ø 160 x 60 mm
Wheels material	Polyurethane
Drive	REAR WHEEL
Total weight	1.800 Kg
Electric motor power	2,0 KW / 12 V.
Hardened battery (standard)	300 Ah / 12 V
Battery charger on board	110 / 240 V-50/60 Hz
Lead acid battery	-
Gel battery	•
Additional autonomy of battery	○
Proportional control on board of all movements	•
Certification to standard 2006/42 CE	•
Made in accordance (not certified) to standard UL508 A	•
Certification (issued by Third Party) to standard UL508 A	○
Drive hydraulic unit	•
Automatic braking system	•
Overloading safety system	•
Pressure safety valves on each movements	•

GB750_TR VERTICAL

Maximum load capacity	750 kg
Standard min. hook's height from the ground	1.605 mm
Standard max. hook's height from the ground	2.805 mm
Possibility to extend height up to (option)	-
Standard max. telescopic extension	1.960 mm
Capacity at standard max. telescopic extension	375 kg
Possibility to extend telescopic extension up to (option)	3.000 mm
Capacity at max.telescopic extension (point 7)	280 kg
Rotation (option)	60° - 150°
Wheelbase	1.200 mm
Dimensions - length	1.650 mm
Dimensions - width	1.200 mm
Dimensions - height	1.600 mm
Adjustable speed from / to	From 0 to 40 m/min
Max. surmountable slope (unloaded)	8%
Max. surmountable slope (loaded)	3%
Front wheels	4 x Ø 160 x 60 mm
Wheels material	Polyurethane
Drive	REAR WHEEL
Total weight	1.800 Kg
Electric motor power	2,0 KW / 12 V.
Hardened battery (standard)	300 Ah / 12 V
Battery charger on board	110 / 240 V-50/60 Hz
Lead acid battery	-
Gel battery	•
Additional autonomy of battery	○
Proportional control on board of all movements	•
Certification to standard 2006/42 CE	•
Made in accordance (not certified) to standard UL508 A	•
Certification (issued by Third Party) to standard UL508 A	○
Drive hydraulic unit	•
Automatic braking system	•
Overloading safety system	•
Pressure safety valves on each movements	•



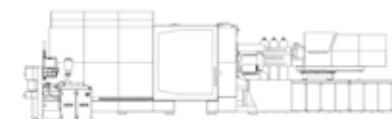

CLAMPING FORCE RANGE 100-280 T.

EN The proper solution for absolute precision positioning of press moulds during lifting operations: from plastic injection producers to aluminium foundries.

IT Gru elettriche ideali per i sollevamenti in cui si richiede una precisione assoluta di posizionamento dello stampo in pressa. Ideale per le aziende di materie plastiche e le fonderie di alluminio.

DE Industriekrane. Werkzeughandlinggeräte übernommen. Sie verfügen über besonders kompakte Baumaße und sehr hohe Traglasten im Arbeitsbereich.

ES La solución ad hoc para las elevaciones en las que es necesaria una precisión absoluta en la colocación del molde en la prensa: desde empresas de materias plásticas a fundiciones de aluminio.

FR Simples à utiliser, sont la solution sur mesure pour les levages qui requièrent une précision de positionnement absolue du moule en presse: des entreprises de matières plastiques aux fonderies d'aluminium.

PT Guindastes móvel hidráulicos para operar em contextos pequenos. Guindastes autopropelidos ideais para setor das matérias plásticas ou em aplicações na manutenção industrial.

MINIDREL 20S_HG

Maximum load capacity	2.000 kg
Standard min. hook's height from the ground	1.800 mm
Standard max. hook's height from the ground	3.600 mm
Possibility to extend height up to (option)	-
Standard max. telescopic extension	1.500 mm
Capacity at standard max. telescopic extension	700 kg
Possibility to extend telescopic extension up to (option)	5.000 mm
Capacity at max.telescopic extension (point 7)	160 kg
Wheelbase	1.250 mm
Dimensions - lenght	1.610 mm
Dimensions - width	950 mm
Dimensions - height	2.320 mm
Adjustable speed from / to	From 0 to 60 m/min
Max. surmountable slope (unloaded)	8%
Max. surmountable slope (loaded)	3%
Front wheels	2 x Ø 160 x 80 mm
Rear driving wheel	1 x Ø 450 x 110 mm
Wheels material	Polyurethane
Drive	REAR WHEEL
Total weight	3.200 Kg
Electric motor power	3,0 KW / 24 cc.
Hardened battery (standard)	280 Ah / 24 V
Battery charger on board	110 / 240 V -50/60 Hz
Lead acid battery	-
Gel battery	•
Additional autonomy of battery	○
Proportional control on board of all movements	•
Certification to standard 2006/42 CE	•
Made in accordance (not certified) to standard UL508 A	•
Certification (issued by Third Party) to standard UL508 A	○
Drive hydraulic unit	•
Automatic braking system	•
Overloading safety system	•
Pressure safety valves on each movements	•

MINIDREL 20S_STD

Maximum load capacity	2.000 kg
Standard min. hook's height from the ground	1.500 mm
Standard max. hook's height from the ground	2.850 mm
Possibility to extend height up to (option)	-
Standard max. telescopic extension	1.500 mm
Capacity at standard max. telescopic extension	700 kg
Possibility to extend telescopic extension up to (option)	5.000 mm
Capacity at max.telescopic extension (point 7)	160 kg
Wheelbase	1.250 mm
Dimensions - lenght	1.610 mm
Dimensions - width	950 mm
Dimensions - height	1.850 mm
Adjustable speed from / to	From 0 to 60 m/min
Max. surmountable slope (unloaded)	8%
Max. surmountable slope (loaded)	3%
Front wheels	2 x Ø 160 x 80 mm
Rear driving wheel	1 x Ø 450 x 110 mm
Wheels material	Polyurethane
Drive	REAR WHEEL
Total weight	3.200 Kg
Electric motor power	3,0 KW / 24 cc.
Hardened battery (standard)	280 Ah / 24 V
Battery charger on board	110 / 240 V -50/60 Hz
Lead acid battery	-
Gel battery	•
Additional autonomy of battery	○
Proportional control on board of all movements	•
Certification to standard 2006/42 CE	•
Made in accordance (not certified) to standard UL508 A	•
Certification (issued by Third Party) to standard UL508 A	○
Drive hydraulic unit	•
Automatic braking system	•
Overloading safety system	•
Pressure safety valves on each movements	•



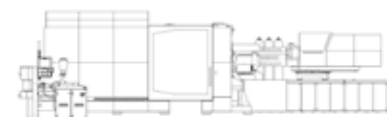

CLAMPING FORCE RANGE 100-320 T.

EN The proper solution for absolute precision positioning of press moulds during lifting operations: from plastic injection producers to aluminium foundries.

IT Gru elettriche ideali per i sollevamenti in cui si richiede una precisione assoluta di posizionamento dello stampo in pressa. Ideale per le aziende di materie plastiche e le fonderie di alluminio.

DE Industriekrane. Werkzeughandlinggeräte übernommen. Sie verfügen über besonders kompakte Baumaße und sehr hohe Traglasten im Arbeitsbereich.

ES La solución ad hoc para las elevaciones en las que es necesaria una precisión absoluta en la colocación del molde en la prensa: desde empresas de materias plásticas a fundiciones de aluminio.

FR Simples à utiliser, sont la solution sur mesure pour les levages qui requièrent une précision de positionnement absolue du moule en presse: des entreprises de matières plastiques aux fonderies d'aluminium.

PT Guindastes móvel hidráulicos para operar em contextos pequenos. Guindastes autopropelidos ideais para setor das matérias plásticas ou em aplicações na manutenção industrial.

MINIDREL 20SL_HG

Maximum load capacity	2.000 kg
Standard min. hook's height from the ground	1.800 mm
Standard max. hook's height from the ground	3.600 mm
Possibility to extend height up to (option)	-
Standard max. telescopic extension	1.500 mm
Capacity at standard max. telescopic extension	1.000 kg
Possibility to extend telescopic extension up to (option)	5.000 mm
Capacity at max.telescopic extension (point 7)	225 kg
Wheelbase	1.500 mm
Dimensions - length	1.860 mm
Dimensions - width	950 mm
Dimensions - height	2.320 mm
Adjustable speed from / to	From 0 to 60 m/min
Max. surmountable slope (unloaded)	8%
Max. surmountable slope (loaded)	3%
Front wheels	2 x Ø 160 x 80 mm
Rear driving wheel	1 x Ø 450 x 110 mm
Wheels material	Polyurethane
Drive	REAR WHEEL
Total weight	3.600 Kg
Electric motor power	3,0 KW / 24 cc.
Hardened battery (standard)	360 Ah / 24 V
Battery charger on board	110 / 240 V -50/60 Hz
Lead acid battery	-
Gel battery	•
Additional autonomy of battery	o
Proportional control on board of all movements	•
Certification to standard 2006/42 CE	•
Made in accordance (not certified) to standard UL508 A	•
Certification (issued by Third Party) to standard UL508 A	o
Drive hydraulic unit	•
Automatic braking system	•
Overloading safety system	•
Pressure safety valves on each movements	•

MINIDREL 20SL_STD

Maximum load capacity	2.000 kg
Standard min. hook's height from the ground	1.500 mm
Standard max. hook's height from the ground	2.850 mm
Possibility to extend height up to (option)	-
Standard max. telescopic extension	1.500 mm
Capacity at standard max. telescopic extension	1.000 kg
Possibility to extend telescopic extension up to (option)	5.000 mm
Capacity at max.telescopic extension (point 7)	225 kg
Wheelbase	1.500 mm
Dimensions - length	1.860 mm
Dimensions - width	950 mm
Dimensions - height	1.850 mm
Adjustable speed from / to	From 0 to 60 m/min
Max. surmountable slope (unloaded)	8%
Max. surmountable slope (loaded)	3%
Front wheels	2 x Ø 160 x 80 mm
Rear driving wheel	1 x Ø 450 x 110 mm
Wheels material	Polyurethane
Drive	REAR WHEEL
Total weight	3.600 Kg
Electric motor power	3,0 KW / 24 cc.
Hardened battery (standard)	360 Ah / 24 V
Battery charger on board	110 / 240 V -50/60 Hz
Lead acid battery	-
Gel battery	•
Additional autonomy of battery	o
Proportional control on board of all movements	•
Certification to standard 2006/42 CE	•
Made in accordance (not certified) to standard UL508 A	•
Certification (issued by Third Party) to standard UL508 A	o
Drive hydraulic unit	•
Automatic braking system	•
Overloading safety system	•
Pressure safety valves on each movements	•



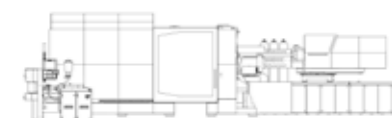

CLAMPING FORCE RANGE 200-600 T.

EN The proper solution for absolute precision positioning of press moulds during lifting operations: from plastic injection producers to aluminium foundries.

IT Gru elettriche ideali per i sollevamenti in cui si richiede una precisione assoluta di posizionamento dello stampo in pressa. Ideale per le aziende di materie plastiche e le fonderie di alluminio.

DE Industriekrane. Werkzeughandlinggeräte übernommen. Sie verfügen über besonders kompakte Baumaße und sehr hohe Traglasten im Arbeitsbereich.

ES La solución ad hoc para las elevaciones en las que es necesaria una precisión absoluta en la colocación del molde en la prensa: desde empresas de materias plásticas a fundiciones de aluminio.

FR Simples à utiliser, sont la solution sur mesure pour les levages qui requièrent une précision de positionnement absolue du moule en presse: des entreprises de matières plastiques aux fonderies d'aluminium.

PT Guindastes móvel hidráulicos para operar em contextos pequenos. Guindastes autopropelidos ideais para setor das matérias plásticas ou em aplicações na manutenção industrial.

MINIDREL 25S_HG

Maximum load capacity	2.500 kg
Standard min. hook's height from the ground	2.400 mm
Standard max. hook's height from the ground	4.800 mm
Possibility to extend height up to (option)	5.000 mm
Standard max. telescopic extension	1.350 mm
Capacity at standard max. telescopic extension	2.500 kg
Possibility to extend telescopic extension up to (option)	3.600 mm
Capacity at max.telescopic extension (point 7)	900 kg
Wheelbase	1.810 mm
Dimensions - length	2.240 mm
Dimensions - width	1.410 mm
Dimensions - height	2.750 / 2.850 / 2.950 mm
Adjustable speed from / to	From 0 to 60 m/min
Max. surmountable slope (unloaded)	8%
Max. surmountable slope (loaded)	3%
Front wheels	2 x Ø300 x 140 mm
Rear driving wheel	1 x Ø 450 x 110 mm
Wheels material	Polyurethane
Drive	REAR WHEEL
Total weight	5.900 Kg
Electric motor power	4,0 KW / 24 cc.
Hardened battery (standard)	420 Ah / 24 V
Battery charger on board	110 / 240 V -50/60 Hz
Lead acid battery	•
Gel battery	○
Additional autonomy of battery	○
Proportional control on board of all movements	•
Certification to standard 2006/42 CE	•
Made in accordance (not certified) to standard UL508 A	•
Certification (issued by Third Party) to standard UL508 A	○
Drive hydraulic unit	•
Automatic braking system	•
Overloading safety system	•
Pressure safety valves on each movements	•

MINIDREL 40S_HG

Maximum load capacity	4.000 kg
Standard min. hook's height from the ground	2.400 mm
Standard max. hook's height from the ground	4.800 mm
Possibility to extend height up to (option)	5.000 mm
Standard max. telescopic extension	1.350 mm
Capacity at standard max. telescopic extension	4.000 kg
Possibility to extend telescopic extension up to (option)	3.600 mm
Capacity at max.telescopic extension (point 7)	1.350 kg
Wheelbase	2.000 mm
Dimensions - length	2.470 mm
Dimensions - width	1.430 mm
Dimensions - height	2.850 / 2.950 / 3.050 mm
Adjustable speed from / to	From 0 to 60 m/min
Max. surmountable slope (unloaded)	8%
Max. surmountable slope (loaded)	3%
Front wheels	2 x Ø300 x 140 mm
Rear driving wheel	1 x Ø 450 x 180 mm
Wheels material	Polyurethane
Drive	REAR WHEEL
Total weight	6.300 Kg
Electric motor power	5,0 KW / 24 cc.
Hardened battery (standard)	420 Ah / 24 V
Battery charger on board	110 / 240 V -50/60 Hz
Lead acid battery	•
Gel battery	○
Additional autonomy of battery	○
Proportional control on board of all movements	•
Certification to standard 2006/42 CE	•
Made in accordance (not certified) to standard UL508 A	•
Certification (issued by Third Party) to standard UL508 A	○
Drive hydraulic unit	•
Automatic braking system	•
Overloading safety system	•
Pressure safety valves on each movements	•



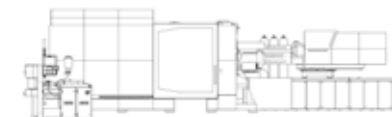

CLAMPING FORCE RANGE 300-800 T.

EN The proper solution for absolute precision positioning of press moulds during lifting operations: from plastic injection producers to aluminium foundries.

IT Gru elettriche ideali per i sollevamenti in cui si richiede una precisione assoluta di posizionamento dello stampo in pressa. Ideale per le aziende di materie plastiche e le fonderie di alluminio.

DE Industriekrane. Werkzeughandlangeräte übernommen. Sie verfügen über besonders kompakte Baumaße und sehr hohe Traglasten im Arbeitsbereich.

ES La solución ad hoc para las elevaciones en las que es necesaria una precisión absoluta en la colocación del molde en la prensa: desde empresas de materias plásticas a fundiciones de aluminio.

FR Simples à utiliser, sont la solution sur mesure pour les levages qui requièrent une précision de positionnement absolue du moule en presse: des entreprises de matières plastiques aux fonderies d'aluminium.

PT Guindastes móvel hidráulicos para operar em contextos pequenos. Guindastes autopropelidos ideais para setor das matérias plásticas ou em aplicações na manutenção industrial.

MINIDREL 50S_HG

Maximum load capacity	5.000 kg
Standard min. hook's height from the ground	2.400 mm
Standard max. hook's height from the ground	4.800 mm
Possibility to extend height up to (option)	5.000 mm
Standard max. telescopic extension	1.350 mm
Capacity at standard max. telescopic extension	5.000 kg
Possibility to extend telescopic extension up to (option)	3.600 mm
Capacity at max.telescopic extension (point 7)	1.700 kg
Wheelbase	2.250 mm
Dimensions - length	2.720 mm
Dimensions - width	1.430 mm
Dimensions - height	2.850 / 2.950 / 3.050 mm
Adjustable speed from / to	From 0 to 60 m/min
Max. surmountable slope (unloaded)	8%
Max. surmountable slope (loaded)	3%
Front wheels	2 x Ø300 x 140 mm
Rear driving wheel	1 x Ø 450 x 180 mm
Wheels material	Polyurethane
Drive	REAR WHEEL
Total weight	6.700 Kg
Electric motor power	5,0 KW / 24 cc.
Hardened battery (standard)	420 Ah / 24 V
Battery charger on board	110 / 240 V -50/60 Hz
Lead acid battery	•
Gel battery	○
Additional autonomy of battery	○
Proportional control on board of all movements	•
Certification to standard 2006/42 CE	•
Made in accordance (not certified) to standard UL508 A	•
Certification (issued by Third Party) to standard UL508 A	○
Drive hydraulic unit	•
Automatic braking system	•
Overloading safety system	•
Pressure safety valves on each movements	•

MINIDREL 60S_HG

Maximum load capacity	6.000 kg
Standard min. hook's height from the ground	2.400 mm
Standard max. hook's height from the ground	4.800 mm
Possibility to extend height up to (option)	5.200 mm
Standard max. telescopic extension	1.350 mm
Capacity at standard max. telescopic extension	6.000 kg
Possibility to extend telescopic extension up to (option)	3.600 mm
Capacity at max.telescopic extension (point 7)	1.900 kg
Wheelbase	2.500 mm
Dimensions - length	2.960 mm
Dimensions - width	1.430 mm
Dimensions - height	2.850 / 2.950 / 3.050 / 3.150 mm
Adjustable speed from / to	From 0 to 60 m/min
Max. surmountable slope (unloaded)	8%
Max. surmountable slope (loaded)	3%
Front wheels	2 x Ø300 x 140 mm
Rear driving wheel	1 x Ø 450 x 180 mm
Wheels material	Polyurethane
Drive	REAR WHEEL
Total weight	7.100 Kg
Electric motor power	5,0 KW / 24 cc.
Hardened battery (standard)	420 Ah / 24 V
Battery charger on board	110 / 240 V -50/60 Hz
Lead acid battery	•
Gel battery	○
Additional autonomy of battery	○
Proportional control on board of all movements	•
Certification to standard 2006/42 CE	•
Made in accordance (not certified) to standard UL508 A	•
Certification (issued by Third Party) to standard UL508 A	○
Drive hydraulic unit	•
Automatic braking system	•
Overloading safety system	•
Pressure safety valves on each movements	•





CLAMPING FORCE RANGE 400-1.000 T.

EN The proper solution for absolute precision positioning of press moulds during lifting operations: from plastic injection producers to aluminium foundries.

IT Gru elettriche ideali per i sollevamenti in cui si richiede una precisione assoluta di posizionamento dello stampo in pressa. Ideale per le aziende di materie plastiche e le fonderie di alluminio.

DE Industriekrane. Werkzeughandlinggeräte übernommen. Sie verfügen über besonders kompakte Baumaße und sehr hohe Traglasten im Arbeitsbereich.

ES La solución ad hoc para las elevaciones en las que es necesaria una precisión absoluta en la colocación del molde en la prensa: desde empresas de materias plásticas a fundiciones de aluminio.

FR Simples à utiliser, sont la solution sur mesure pour les levages qui requièrent une précision de positionnement absolue du moule en presse: des entreprises de matières plastiques aux fonderies d'aluminium.

PT Guindastes móvel hidráulicos para operar em contextos pequenos. Guindastes autopropelidos ideais para setor das matérias plásticas ou em aplicações na manutenção industrial.

MINIDREL 75S_HG

Maximum load capacity	7.500 kg
Standard min. hook's height from the ground	2.600 mm
Standard max. hook's height from the ground	5.200 mm
Possibility to extend height up to (option)	-
Standard max. telescopic extension	1.350 mm
Capacity at standard max. telescopic extension	7.500 kg
Possibility to extend telescopic extension up to (option)	3.600 mm
Capacity at max.telescopic extension (point 7)	2.400 kg
Wheelbase	2.620 mm
Dimensions - length	3.250 mm
Dimensions - width	1.490 mm
Dimensions - height	3.400 mm
Adjustable speed from / to	From 0 to 60 m/min
Max. surmountable slope (unloaded)	8%
Max. surmountable slope (loaded)	3%
Front wheels	4 x Ø300 x 140 mm
Rear driving wheel	2 x Ø 450 x 110 mm
Wheels material	Polyurethane
Drive	REAR WHEEL
Total weight	10.100 Kg
Electric motor power	8,0 KW / 48 cc.
Hardened battery (standard)	560 Ah / 48V
Battery charger on board	380 /440 V -50/60 Hz
Lead acid battery	•
Gel battery	○
Additional autonomy of battery	○
Proportional control on board of all movements	•
Certification to standard 2006/42 CE	•
Made in accordance (not certified) to standard UL508 A	•
Certification (issued by Third Party) to standard UL508 A	○
Drive hydraulic unit	•
Automatic braking system	•
Overloading safety system	•
Pressure safety valves on each movements	•

MINIDREL 100S_HG

Maximum load capacity	10.000 kg
Standard min. hook's height from the ground	2.600 mm
Standard max. hook's height from the ground	5.200 mm
Possibility to extend height up to (option)	-
Standard max. telescopic extension	1.350 mm
Capacity at standard max. telescopic extension	10.000 kg
Possibility to extend telescopic extension up to (option)	3.600 mm
Capacity at max.telescopic extension (point 7)	3.300 kg
Wheelbase	2.990 mm
Dimensions - length	3.595 mm
Dimensions - width	1.490 mm
Dimensions - height	3.400 mm
Adjustable speed from / to	From 0 to 60 m/min
Max. surmountable slope (unloaded)	8%
Max. surmountable slope (loaded)	3%
Front wheels	4 x Ø300 x 140 mm
Rear driving wheel	2 x Ø 450 x 110 mm
Wheels material	Polyurethane
Drive	REAR WHEEL
Total weight	11.500 Kg
Electric motor power	8,0 KW / 48 cc.
Hardened battery (standard)	560 Ah / 48V
Battery charger on board	380 /440 V - 50/60 Hz
Lead acid battery	•
Gel battery	○
Additional autonomy of battery	○
Proportional control on board of all movements	•
Certification to standard 2006/42 CE	•
Made in accordance (not certified) to standard UL508 A	•
Certification (issued by Third Party) to standard UL508 A	○
Drive hydraulic unit	•
Automatic braking system	•
Overloading safety system	•
Pressure safety valves on each movements	•



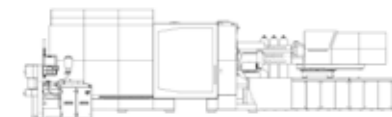

CLAMPING FORCE RANGE 700-1.300 T.

EN The proper solution for absolute precision positioning of press moulds during lifting operations: from plastic injection producers to aluminium foundries.

IT Gru elettriche ideali per i sollevamenti in cui si richiede una precisione assoluta di posizionamento dello stampo in pressa. Ideale per le aziende di materie plastiche e le fonderie di alluminio.

DE Industriekrane. Werkzeughandlinggeräte übernommen. Sie verfügen über besonders kompakte Baumaße und sehr hohe Traglasten im Arbeitsbereich.

ES La solución ad hoc para las elevaciones en las que es necesaria una precisión absoluta en la colocación del molde en la prensa: desde empresas de materias plásticas a fundiciones de aluminio.

FR Simples à utiliser, sont la solution sur mesure pour les levages qui requièrent une précision de positionnement absolue du moule en presse: des entreprises de matières plastiques aux fonderies d'aluminium.

PT Guindastes móvel hidráulicos para operar em contextos pequenos. Guindastes autopropelidos ideais para setor das matérias plásticas ou em aplicações na manutenção industrial.

MINIDREL 120S_HG

Maximum load capacity	12.000 kg
Standard min. hook's height from the ground	2.600 mm
Standard max. hook's height from the ground	5.200 mm
Possibility to extend height up to (option)	-
Standard max. telescopic extension	1.350 mm
Capacity at standard max. telescopic extension	12.000 kg
Possibility to extend telescopic extension up to (option)	3.600 mm
Capacity at max.telescopic extension (point 7)	4.000 kg
Wheelbase	3.500 mm
Dimensions - lenght	4.160 mm
Dimensions - width	1.780 mm
Dimensions - height	3.400 mm
Adjustable speed from / to	From 0 to 60 m/min
Max. surmountable slope (unloaded)	8%
Max. surmountable slope (loaded)	3%
Front wheels	4 x Ø300 x 180 mm
Rear driving wheel	2 x Ø 450 x 180 mm
Wheels material	Polyurethane
Drive	REAR WHEEL
Total weight	14.700 Kg
Electric motor power	12,0 KW / 48 cc.
Hardened battery (standard)	560 Ah / 48V
Battery charger on board	380 /440 V -50/60 Hz
Lead acid battery	•
Gel battery	○
Additional autonomy of battery	○
Proportional control on board of all movements	•
Certification to standard 2006/42 CE	•
Made in accordance (not certified) to standard UL508 A	•
Certification (issued by Third Party) to standard UL508 A	○
Drive hydraulic unit	•
Automatic braking system	•
Overloading safety system	•
Pressure safety valves on each movements	•

MINIDREL 150S_HG

Maximum load capacity	15.000 kg
Standard min. hook's height from the ground	2.600 mm
Standard max. hook's height from the ground	5.200 mm
Possibility to extend height up to (option)	-
Standard max. telescopic extension	1.350 mm
Capacity at standard max. telescopic extension	15.000 kg
Possibility to extend telescopic extension up to (option)	3.600 mm
Capacity at max.telescopic extension (point 7)	5.000 kg
Wheelbase	3.500 mm
Dimensions - lenght	4.160 mm
Dimensions - width	1.780 mm
Dimensions - height	3.400 mm
Adjustable speed from / to	From 0 to 60 m/min
Max. surmountable slope (unloaded)	8%
Max. surmountable slope (loaded)	3%
Front wheels	4 x Ø300 x 180 mm
Rear driving wheel	2 x Ø 450 x 180 mm
Wheels material	Polyurethane
Drive	REAR WHEEL
Total weight	15.600 Kg
Electric motor power	12,0 KW / 48 cc.
Hardened battery (standard)	560 Ah / 48V
Battery charger on board	380 /440 V -50/60 Hz
Lead acid battery	•
Gel battery	○
Additional autonomy of battery	○
Proportional control on board of all movements	•
Certification to standard 2006/42 CE	•
Made in accordance (not certified) to standard UL508 A	•
Certification (issued by Third Party) to standard UL508 A	○
Drive hydraulic unit	•
Automatic braking system	•
Overloading safety system	•
Pressure safety valves on each movements	•



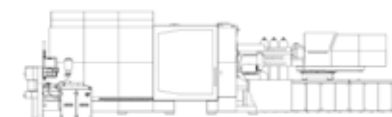

CLAMPING FORCE RANGE 1.000-4.000 T.

EN The proper solution for absolute precision positioning of press moulds during lifting operations: from plastic injection producers to aluminium foundries.

IT Gru elettriche ideali per i sollevamenti in cui si richiede una precisione assoluta di posizionamento dello stampo in pressa. Ideale per le aziende di materie plastiche e le fonderie di alluminio.

DE Industriekrane. Werkzeughandlangeräte übernommen. Sie verfügen über besonders kompakte Baumaße und sehr hohe Traglasten im Arbeitsbereich.

ES La solución ad hoc para las elevaciones en las que es necesaria una precisión absoluta en la colocación del molde en la prensa: desde empresas de materias plásticas a fundiciones de aluminio.

FR Simples à utiliser, sont la solution sur mesure pour les levages qui requièrent une précision de positionnement absolue du moule en presse: des entreprises de matières plastiques aux fonderies d'aluminium.

PT Guindastes móvel hidráulicos para operar em contextos pequenos. Guindastes autopropelidos ideais para setor das matérias plásticas ou em aplicações na manutenção industrial.

TRANSIDREL 300B/350B

Maximum load capacity	35.000 kg
Standard min. height from the ground	700 mm (table)
Standard max. height from the ground	950 mm (table)
Possibility to extend height up to (option)	1.900 mm (table)
Frontal mould handling	Yes
Lateral mould handling	Yes
N° of independent pushers	2
N° of independent stabilizers	4
Wheelbase	2.100 mm
Dimensions - length	3.050 mm
Dimensions - width	2.410 mm
Dimensions - height	2.180 mm
Adjustable speed from / to	From 0 to 100 m/min
Max. surmountable slope (unloaded)	8%
Max. surmountable slope (loaded)	3%
Front wheels	4 x ø 600 x 200 mm
Rear driving wheel	2 x ø 533 x 206 mm
Wheels material	Polyurethane
Drive	TWO WHEELS
Total weight	14.800 kg
Electric motor power	10,0 KW / 48 cc.
Hardened battery (standard)	700 Ah / 48V
Battery charger on board	380 /440 V -50/60 Hz
Lead acid battery	•
Gel battery	○
Additional autonomy of battery	○
Proportional control on board of all movements	•
Certification to standard 2006/42 CE	•
Made in accordance (not certified) to standard UL508 A	•
Certification (issued by Third Party) to standard UL508 A	○
Drive hydraulic unit	•
Automatic braking system	•
Overloading safety system	•
Pressure safety valves on each movements	•

TRANSIDREL 500B

Maximum load capacity	50.000 kg
Standard min. height from the ground	700 mm (table)
Standard max. height from the ground	950 mm (table)
Possibility to extend height up to (option)	1.900 mm (table)
Frontal mould handling	Yes
Lateral mould handling	Yes
N° of independent pushers	2
N° of independent stabilizers	4
Wheelbase	2.800 mm
Dimensions - length	3.750 mm
Dimensions - width	2.410 mm
Dimensions - height	2.180 mm
Adjustable speed from / to	From 0 to 100 m/min
Max. surmountable slope (unloaded)	8%
Max. surmountable slope (loaded)	3%
Front wheels	4 x ø 600 x 200 mm
Rear driving wheel	2 x ø 533 x 206 mm
Wheels material	Polyurethane
Drive	TWO WHEELS
Total weight	16.800 kg
Electric motor power	12,0 KW / 48 cc.
Hardened battery (standard)	725 Ah / 48V
Battery charger on board	380 /440 V -50/60 Hz
Lead acid battery	•
Gel battery	○
Additional autonomy of battery	○
Proportional control on board of all movements	•
Certification to standard 2006/42 CE	•
Made in accordance (not certified) to standard UL508 A	•
Certification (issued by Third Party) to standard UL508 A	○
Drive hydraulic unit	•
Automatic braking system	•
Overloading safety system	•
Pressure safety valves on each movements	•





EN Lifting capacity of up to 40% more than traditional cranes of equal size. These mobile cranes are suitable for indoor and outdoor use in both civil and industrial environments.

IT Le gru semoventi elettriche GT cranes, oltre ad essere adatte ad essere utilizzate in ambito industriale, sono dotate di un sistema di sollevamento brevettato che garantisce una capacità di sollevamento fino al 40% in più rispetto alle gru tradizionali di pari dimensioni.

DE Der Selbstfahrende Kräne ist in seiner Art einzigartig: dank eines patentierten Hubsystems, das eine höhere Hubleistung von bis zu 40% gegenüber herkömmlichen Kränen gleicher Größe gewährleistet.

ES Una grúa móvil única en su género: gracias a un sistema de elevación patentado que garantiza una capacidad de elevación máxima de un 40% más respecto a las grúas tradicionales de las mismas dimensiones.

FR Les mini grues compactes électriques GT cranes Gruniverpal sont simples d'utilisation. Ils sont parfaits pour effectuer des opérations de maintenance industrielle.

PT O guindaste automotriz único no seu género: graças a um sistema de elevação patenteado que garante uma capacidade de elevação até 40% maior em relação aos guindastes tradicionais de dimensões iguais.

MINIDREL 30B_STD

Maximum load capacity	3.000 kg
Standard min. height from the ground	1.500 mm
Standard max. height from the ground	5.500 mm
Possibility to extend height up to (option)	7.000 mm
Standard max. telescopic extension	1.500 mm
Capacity at standard max. telescopic extension	1.000 kg
Possibility to extend telescopic extension up to (option)	5.800 mm
Capacity at max.telescopic extension (point 7)	100 kg
Wheelbase	1.850 mm
Dimensions - length	2.180 mm
Dimensions - width	1.430 mm
Dimensions - height	2.370 mm
Adjustable speed from / to	From 0 to 60 m/min
Max. surmountable slope (unloaded)	8%
Max. surmountable slope (loaded)	3%
Front wheels	2 x Ø 200 x 120 mm
Rear driving wheel	1 x Ø 450 x 110 mm
Wheels material	Polyurethane
Drive	REAR WHEEL
Total weight	1.900 Kg
Electric motor power	3,0 KW / 24 cc.
Hardened battery (standard)	420Ah / 24 V
Battery charger on board	110 / 240 V -50/60 Hz
Lead acid battery	•
Gel battery	○
Additional autonomy of battery	○
Proportional control on board of all movements	•
Certification to standard 2006/42 CE	•
Made in accordance (not certified) to standard UL508 A	•
Certification (issued by Third Party) to standard UL508 A	○
Drive hydraulic unit	•
Automatic braking system	•
Overloading safety system	•
Pressure safety valves on each movements	•

MINIDREL 30B_CMP / 30B_ADW

Maximum load capacity	3.000 kg
Standard min. height from the ground	1.000 mm
Standard max. height from the ground	4.500 mm
Possibility to extend height up to (option)	5.500 mm
Standard max. telescopic extension	1.500 mm
Capacity at standard max. telescopic extension	1.000 kg
Possibility to extend telescopic extension up to (option)	5.800 mm
Capacity at max.telescopic extension (point 7)	100 kg
Wheelbase	1.850 mm
Dimensions - length	2.180 mm
Dimensions - width	970 mm
Dimensions - height	2.000 mm
Adjustable speed from / to	From 0 to 60 m/min
Max. surmountable slope (unloaded)	8%
Max. surmountable slope (loaded)	3%
Front wheels	2 x Ø 200 x 120 mm
Rear driving wheel	1 x Ø 450 x 110 mm
Wheels material	Polyurethane
Drive	REAR WHEEL
Total weight	1.900 Kg
Electric motor power	3,0 KW / 24 cc.
Hardened battery (standard)	420Ah / 24 V
Battery charger on board	110 / 240 V -50/60 Hz
Lead acid battery	•
Gel battery	○
Additional autonomy of battery	○
Proportional control on board of all movements	•
Certification to standard 2006/42 CE	•
Made in accordance (not certified) to standard UL508 A	•
Certification (issued by Third Party) to standard UL508 A	○
Drive hydraulic unit	•
Automatic braking system	•
Overloading safety system	•
Pressure safety valves on each movements	•



MINIDREL 50B_WVR / MINIDREL 50B_R

MINIDREL 50B_WVR / MINIDREL 50B_R



MINIDREL 50B_WVR

Maximum load capacity	5.000 kg
Standard min. height from the ground	1.200 mm
Standard max. height from the ground	7.500 mm
Possibility to extend height up to (option)	8.500 mm
Standard max. telescopic extension	4.500 mm
Capacity at standard max. telescopic extension	1.000 kg
Possibility to extend telescopic extension up to (option)	5.600 mm
Capacity at max.telescopic extension (point 7)	725 kg
Wheelbase	1.960 mm
Dimensions - length	2.660 mm
Dimensions - width	1.350 mm
Dimensions - height	2.520 mm / 2.980 mm
Adjustable speed from / to	From 0 to 100 m/min
Max. surmountable slope (unloaded)	16%
Max. surmountable slope (loaded)	8%
Front wheels	2 x ø 533 x 178 mm
Rear driving wheel	2 x ø 457x 152 mm
Wheels material	Cushion
Drive	FOUR WHEELS
Total weight	7.400 Kg
Electric motor power	8,0 KW / 48 cc.
Hardened battery (standard)	520 Ah / 48V
Battery charger on board	380 /440 V -50/60 Hz
Lead acid battery	•
Gel battery	○
Additional autonomy of battery	○
Proportional control on board of all movements	•
Certification to standard 2006/42 CE	•
Made in accordance (not certified) to standard UL508 A	•
Certification (issued by Third Party) to standard UL508 A	○
Drive hydraulic unit	•
Automatic braking system	•
Overloading safety system	•
Pressure safety valves on each movements	•

MINIDREL 50B_R

Maximum load capacity	5.000 kg
Standard min. height from the ground	1.200 mm
Standard max. height from the ground	7.500 mm
Possibility to extend height up to (option)	8.500 mm
Standard max. telescopic extension	4.500 mm
Capacity at standard max. telescopic extension	1.000 kg
Possibility to extend telescopic extension up to (option)	5.600 mm
Capacity at max.telescopic extension (point 7)	725 kg
Wheelbase	2.400 mm
Dimensions - length	3.220 mm
Dimensions - width	1.350 mm
Dimensions - height	2.520 mm
Adjustable speed from / to	From 0 to 100 m/min
Max. surmountable slope (unloaded)	16%
Max. surmountable slope (loaded)	8%
Front wheels	2 x ø 533 x 178 mm
Rear driving wheel	2 x ø 457x 152 mm
Wheels material	Cushion
Drive	FOUR WHEELS
Total weight	6.200 Kg
Electric motor power	5,0 KW / 48V
Hardened battery (standard)	520 Ah / 48V
Battery charger on board	380 /440 V -50/60 Hz
Lead acid battery	•
Gel battery	○
Additional autonomy of battery	○
Proportional control on board of all movements	•
Certification to standard 2006/42 CE	•
Made in accordance (not certified) to standard UL508 A	•
Certification (issued by Third Party) to standard UL508 A	○
Drive hydraulic unit	•
Automatic braking system	•
Overloading safety system	•
Pressure safety valves on each movements	•

EN Lifting capacity of up to 40% more than traditional cranes of equal size. These mobile cranes are suitable for indoor and outdoor use in both civil and industrial environments.

IT Le gru semoventi elettriche GT cranes, oltre ad essere adatte ad essere utilizzate in ambito industriale, sono dotate di un sistema di sollevamento brevettato che garantisce una capacità di sollevamento fino al 40% in più rispetto alle gru tradizionali di pari dimensioni.

DE Der Selbstfahrende Kräne ist in seiner Art einzigartig: dank eines patentierten Hubsystems, das eine höhere Hubleistung von bis zu 40% gegenüber herkömmlichen Kränen gleicher Größe gewährleistet.

ES Una grúa móvil única en su género: gracias a un sistema de elevación patentado que garantiza una capacidad de elevación máxima de un 40% más respecto a las grúas tradicionales de las mismas dimensiones.

FR Les mini grues compactes électriques GT cranes Gruniverpal sont simples d'utilisation. Ils sont parfaits pour effectuer des opérations de maintenance industrielle.

PT O guindaste automotriz único no seu género: graças a um sistema de elevação patenteado que garante uma capacidade de elevação até 40% maior em relação aos guindastes tradicionais de dimensões iguais.





MINIDREL 75B_TRS

Maximum load capacity	7.500 kg
Standard min. height from the ground	1.200 mm
Standard max. height from the ground	7.500 mm
Possibility to extend height up to (option)	8.500 mm
Standard max. telescopic extension	4.500 mm
Capacity at standard max. telescopic extension	1.500 kg
Possibility to extend telescopic extension up to (option)	7.300 mm
Capacity at max.telescopic extension (point 7)	1.000 kg
Rotation (option)	190°
Wheelbase	2.500 mm
Dimensions - length	3.450 mm
Dimensions - width	1.750 mm
Dimensions - height	2.700 mm
Adjustable speed from / to	From 0 to 100 m/min
Max. surmountable slope (unloaded)	16%
Max. surmountable slope (loaded)	8%
Front wheels	2 x ø 533 x 230 mm
Rear driving wheel	2 x ø 457 x 180 mm
Wheels material	Cushion
Drive	FOUR WHEELS
Total weight	8.300 Kg
Electric motor power	8,0 KW / 48 cc.
Hardened battery (standard)	560 Ah / 48V
Battery charger on board	380 /440 V -50/60 Hz
Lead acid battery	•
Gel battery	○
Additional autonomy of battery	○
Proportional control on board of all movements	•
Certification to standard 2006/42 CE	•
Made in accordance (not certified) to standard UL508 A	•
Certification (issued by Third Party) to standard UL508 A	○
Drive hydraulic unit	•
Automatic braking system	•
Overloading safety system	•

MINIDREL 75B_R

Maximum load capacity	7.500 kg
Standard min. height from the ground	1.200 mm
Standard max. height from the ground	7.500 mm
Possibility to extend height up to (option)	8.500 mm
Standard max. telescopic extension	4.500 mm
Capacity at standard max. telescopic extension	1.500 kg
Possibility to extend telescopic extension up to (option)	5.500 mm
Capacity at max.telescopic extension (point 7)	1.000 kg
Rotation (option)	-
Wheelbase	2.750 mm
Dimensions - length	3.650 mm
Dimensions - width	1.350 mm
Dimensions - height	2.650 mm
Adjustable speed from / to	From 0 to 100 m/min
Max. surmountable slope (unloaded)	16%
Max. surmountable slope (loaded)	8%
Front wheels	2 x ø 533 x 230 mm
Rear driving wheel	2 x ø 457 x 180 mm
Wheels material	Cushion
Drive	FOUR WHEELS
Total weight	6.900 Kg
Electric motor power	8,0 KW / 48 cc.
Hardened battery (standard)	560 Ah / 48V
Battery charger on board	380 /440 V -50/60 Hz
Lead acid battery	•
Gel battery	○
Additional autonomy of battery	○
Proportional control on board of all movements	•
Certification to standard 2006/42 CE	•
Made in accordance (not certified) to standard UL508 A	•
Certification (issued by Third Party) to standard UL508 A	○
Drive hydraulic unit	•
Automatic braking system	•
Overloading safety system	•

EN Lifting capacity of up to 40% more than traditional cranes of equal size. These mobile cranes are suitable for indoor and outdoor use in both civil and industrial environments.

IT Le gru semoventi elettriche GT cranes, oltre ad essere adatte ad essere utilizzate in ambito industriale, sono dotate di un sistema di sollevamento brevettato che garantisce una capacità di sollevamento fino al 40% in più rispetto alle gru tradizionali di pari dimensioni.

DE Der Selbstfahrende Kräne ist in seiner Art einzigartig: dank eines patentierten Hubsystems, das eine höhere Hubleistung von bis zu 40% gegenüber herkömmlichen Kränen gleicher Größe gewährleistet.

ES Una grúa móvil única en su género: gracias a un sistema de elevación patentado que garantiza una capacidad de elevación máxima de un 40% más respecto a las grúas tradicionales de las mismas dimensiones.

FR Les mini grues compactes électriques GT cranes Gruniverpal sont simples d'utilisation. Ils sont parfaits pour effectuer des opérations de maintenance industrielle.

PT O guindaste automotriz único no seu género: graças a um sistema de elevação patenteado que garante uma capacidade de elevação até 40% maior em relação aos guindastes tradicionais de dimensões iguais.





EN Lifting capacity of up to 40% more than traditional cranes of equal size. These mobile cranes are suitable for indoor and outdoor use in both civil and industrial environments.

IT Le gru semoventi elettriche GT cranes, oltre ad essere adatte ad essere utilizzate in ambito industriale, sono dotate di un sistema di sollevamento brevettato che garantisce una capacità di sollevamento fino al 40% in più rispetto alle gru tradizionali di pari dimensioni.

DE Der Selbstfahrende Kräne ist in seiner Art einzigartig: dank eines patentierten Hubsystems, das eine höhere Hubleistung von bis zu 40% gegenüber herkömmlichen Kränen gleicher Größe gewährleistet.

ES Una grúa móvil única en su género: gracias a un sistema de elevación patentado que garantiza una capacidad de elevación máxima de un 40% más respecto a las grúas tradicionales de las mismas dimensiones.

FR Les mini grues compactes électriques GT cranes Gruniverpal sont simples d'utilisation. Ils sont parfaits pour effectuer des opérations de maintenance industrielle.

PT O guindaste automotriz único no seu género: graças a um sistema de elevação patenteado que garante uma capacidade de elevação até 40% maior em relação aos guindastes tradicionais de dimensões iguais.

MINIDREL 90B_R

Maximum load capacity	9.000 kg
Standard min. height from the ground	1.200 mm
Standard max. height from the ground	7.500 mm
Possibility to extend height up to (option)	8.500 mm
Standard max. telescopic extension	4.500 mm
Capacity at standard max. telescopic extension	2.100 Kg
Possibility to extend telescopic extension up to (option)	5.500 mm
Capacity at max.telescopic extension (point 7)	1.300 Kg
Wheelbase	2.900 mm
Dimensions - length	3.810 mm
Dimensions - width	1.500 mm
Dimensions - height	2.520 mm / 2.650 mm
Adjustable speed from / to	From 0 to 100 m/min
Max. surmountable slope (unloaded)	16%
Max. surmountable slope (loaded)	8%
Front wheels	2 x ø 533 x 230 mm
Rear driving wheel	2 x ø 533 x 178 mm
Wheels material	Cushion
Drive	FOUR WHEELS
Total weight	9.700 Kg
Electric motor power	10,0 KW / 48 cc.
Hardened battery (standard)	660 Ah / 48V
Battery charger on board	380 /440 V -50/60 Hz
Lead acid battery	•
Gel battery	○
Additional autonomy of battery	○
Proportional control on board of all movements	•
Certification to standard 2006/42 CE	•
Made in accordance (not certified) to standard UL508 A	•
Certification (issued by Third Party) to standard UL508 A	○
Drive hydraulic unit	•
Automatic braking system	•
Overloading safety system	•
Pressure safety valves on each movements	•

MINIDREL 90B_MSR

Maximum load capacity	9.000 Kg
Standard min. height from the ground	100 mm
Standard max. height from the ground	5.800 mm
Possibility to extend height up to (option)	-
Standard max. telescopic extension	4.900 mm
Capacity at standard max. telescopic extension	1.900 kg
Possibility to extend telescopic extension up to (option)	-
Capacity at max.telescopic extension (point 7)	-
Wheelbase	2.900 mm
Dimensions - length	3.810 mm
Dimensions - width	1.350 mm / 1.500 mm
Dimensions - height	2.650 mm
Adjustable speed from / to	From 0 to 100 m/min
Max. surmountable slope (unloaded)	16%
Max. surmountable slope (loaded)	8%
Front wheels	2 x ø 533 x 230 mm
Rear driving wheel	2 x ø 533 x 178 mm
Wheels material	Cushion
Drive	FOUR WHEELS
Total weight	9.700 Kg
Electric motor power	10,0 KW / 48 cc.
Hardened battery (standard)	660 Ah / 48V
Battery charger on board	380 /440 V -50/60 Hz
Lead acid battery	•
Gel battery	○
Additional autonomy of battery	○
Proportional control on board of all movements	•
Certification to standard 2006/42 CE	•
Made in accordance (not certified) to standard UL508 A	•
Certification (issued by Third Party) to standard UL508 A	○
Drive hydraulic unit	•
Automatic braking system	•
Overloading safety system	•
Pressure safety valves on each movements	•





EN Lifting capacity of up to 40% more than traditional cranes of equal size. These mobile cranes are suitable for indoor and outdoor use in both civil and industrial environments.

IT Le gru semoventi elettriche GT cranes, oltre ad essere adatte ad essere utilizzate in ambito industriale, sono dotate di un sistema di sollevamento brevettato che garantisce una capacità di sollevamento fino al 40% in più rispetto alle gru tradizionali di pari dimensioni.

DE Der Selbstfahrende Kräne ist in seiner Art einzigartig: dank eines patentierten Hubsystems, das eine höhere Hubleistung von bis zu 40% gegenüber herkömmlichen Kränen gleicher Größe gewährleistet.

ES Una grúa móvil única en su género: gracias a un sistema de elevación patentado que garantiza una capacidad de elevación máxima de un 40% más respecto a las grúas tradicionales de las mismas dimensiones.

FR Les mini grues compactes électriques GT cranes Gruniverpal sont simples d'utilisation. Ils sont parfaits pour effectuer des opérations de maintenance industrielle.

PT O guindaste automotriz único no seu género: graças a um sistema de elevação patenteado que garante uma capacidade de elevação até 40% maior em relação aos guindastes tradicionais de dimensões iguais.

MINIDREL 125B_TRS / 125B_R

Maximum load capacity	12.500 kg
Standard min. height from the ground	1.200 mm
Standard max. height from the ground	7.500 mm
Possibility to extend height up to (option)	8.500 mm
Standard max. telescopic extension	4.500 mm
Capacity at standard max. telescopic extension	2.500 kg
Possibility to extend telescopic extension up to (option)	5.500 mm
Capacity at max.telescopic extension (point 7)	1.750 kg
Rotation (option)	210° / -
Wheelbase	2.500 mm / 3.000 mm
Dimensions - length	3.615 mm / 3.920 mm
Dimensions - width	2.050 mm / 1.850 mm
Dimensions - height	2.650 mm
Adjustable speed from / to	From 0 to 100 m/min
Max. surmountable slope (unloaded)	16%
Max. surmountable slope (loaded)	8%
Front wheels	2 x ø711 x 356 mm
Rear driving wheel	2 x ø533 x 178 mm
Wheels material	Cushion
Drive	FOUR WHEELS
Total weight	13.600 Kg / 12.800 kg
Electric motor power	12,0 KW / 78 cc.
Hardened battery (standard)	725 Ah / 78V
Battery charger on board	380 /440 V -50/60 Hz
Lead acid battery	•
Gel battery	○
Additional autonomy of battery	○
Proportional control on board of all movements	•
Certification to standard 2006/42 CE	•
Made in accordance (not certified) to standard UL508 A	•
Certification (issued by Third Party) to standard UL508 A	○
Drive hydraulic unit	•
Automatic braking system	•
Overloading safety system	•

MINIDREL 150B_R

Maximum load capacity	15.000 kg
Standard min. height from the ground	1.200 mm
Standard max. height from the ground	7.500 mm
Possibility to extend height up to (option)	8.500 mm
Standard max. telescopic extension	4.500 mm
Capacity at standard max. telescopic extension	3.000 kg
Possibility to extend telescopic extension up to (option)	5.500 mm
Capacity at max.telescopic extension (point 7)	2.100 kg
Rotation (option)	-
Wheelbase	3.250 mm
Dimensions - length	4.250 mm
Dimensions - width	1.850 mm
Dimensions - height	2.650 mm
Adjustable speed from / to	From 0 to 100 m/min
Max. surmountable slope (unloaded)	16%
Max. surmountable slope (loaded)	8%
Front wheels	2 x ø711 x 356 mm
Rear driving wheel	2 x ø533 x 178 mm
Wheels material	Cushion
Drive	FOUR WHEELS
Total weight	14.600 Kg
Electric motor power	16,0 KW / 78 cc.
Hardened battery (standard)	725 Ah / 78V
Battery charger on board	380 /440 V -50/60 Hz
Lead acid battery	•
Gel battery	○
Additional autonomy of battery	○
Proportional control on board of all movements	•
Certification to standard 2006/42 CE	•
Made in accordance (not certified) to standard UL508 A	•
Certification (issued by Third Party) to standard UL508 A	○
Drive hydraulic unit	•
Automatic braking system	•
Overloading safety system	•





EN Lifting capacity of up to 40% more than traditional cranes of equal size. These mobile cranes are suitable for indoor and outdoor use in both civil and industrial environments.

IT Le gru semoventi elettriche GT cranes, oltre ad essere adatte ad essere utilizzate in ambito industriale, sono dotate di un sistema di sollevamento brevettato che garantisce una capacità di sollevamento fino al 40% in più rispetto alle gru tradizionali di pari dimensioni.

DE Der Selbstfahrende Kräne ist in seiner Art einzigartig: dank eines patentierten Hubsystems, das eine höhere Hubleistung von bis zu 40% gegenüber herkömmlichen Kränen gleicher Größe gewährleistet.

ES Una grúa móvil única en su género: gracias a un sistema de elevación patentado que garantiza una capacidad de elevación máxima de un 40% más respecto a las grúas tradicionales de las mismas dimensiones.

FR Les mini grues compactes électriques GT cranes Gruniverpal sont simples d'utilisation. Ils sont parfaits pour effectuer des opérations de maintenance industrielle.

PT O guindaste automotriz único no seu género: graças a um sistema de elevação patenteado que garante uma capacidade de elevação até 40% maior em relação aos guindastes tradicionais de dimensões iguais.



MINIDREL 250B_TRS

Maximum load capacity	25.000 kg
Standard min. height from the ground	1.200 mm
Standard max. height from the ground	8.500 mm
Possibility to extend height up to (option)	10.500 mm
Standard max. telescopic extension	5.500 mm
Capacity at standard max. telescopic extension	5.400 kg
Possibility to extend telescopic extension up to (option)	7.200 mm
Capacity at max.telescopic extension (point 7)	3.600 kg
Rotation (option)	210°
Wheelbase	3.250 mm
Dimensions - length	4.550 mm
Dimensions - width	2.300 mm
Dimensions - height	2.890 mm
Adjustable speed from / to	From 0 to 100 m/min
Max. surmountable slope (unloaded)	16%
Max. surmountable slope (loaded)	8%
Front wheels	4 x ø711 x 305 mm
Rear driving wheel	2 x ø660 x 356 mm
Wheels material	Cushion
Drive	SIX WHEELS
Total weight	24.400 Kg
Electric motor power	24,0 KW / 78 cc.
Hardened battery (standard)	900 Ah / 78V
Battery charger on board	380 /440 V -50/60 Hz
Lead acid battery	•
Gel battery	○
Additional autonomy of battery	○
Proportional control on board of all movements	•
Certification to standard 2006/42 CE	•
Made in accordance (not certified) to standard UL508 A	•
Certification (issued by Third Party) to standard UL508 A	○
Drive hydraulic unit	•
Automatic braking system	•
Overloading safety system	•



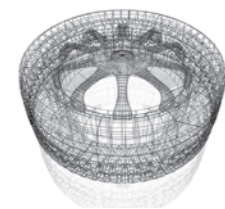

EN GT cranes is the range of mobile cranes chosen by the world's largest manufacturers of tyres and inner tubes: motorcycles, light vehicles, cars, trucks and heavy equipment, earthmoving, civil engineering, aviation.

IT GT cranes è il marchio prescelto dai più grandi produttori mondiali di pneumatici e camera d'aria: motocicli, veicoli leggeri, automobili, autocarro e mezzi pesanti, movimento terra, genio civile, aviazione..

DE GT cranes ist sie die auserwählte Marke der größten Reifen- und Schlauchherstellern weltweit: Motorräder, Leichtfahrzeuge, Autos, Lastwagen und Schwerfahrzeuge, Erdbewegung, Bauwesen, Luftfahrt.

ES GT cranes es la marca escogida por los mayores productores mundiales de neumáticos y cámaras de aire: motocicletas, vehículos ligeros, automóviles, camiones y medios pesados, movimiento de tierras, ingeniería civil, aviación.

FR GT cranes est choisie par les plus grands producteurs mondiaux de pneus et de chambres à air: motocycles, véhicules légers, automobiles, camions et poids-lourds, terrassement, génie civil, aviation.

PT GT cranes é a marca escolhida pelos maiores produtores mundiais de pneus e câmaras de ar: motocicletas, veículos ligeiros, automóveis, caminhões e meios pesados, terraplenagem, engenharia civil, aviação.

GB100

Maximum load capacity	100 kg
Standard min. height from the ground	500 mm
Standard max. height from the ground	2.600 mm
Standard max. telescopic extension	1.500 mm
Capacity at standard max. telescopic extension	100 kg
Wheelbase	1.000 mm
Dimensions - length	1.560 mm
Dimensions - width	820 mm
Dimensions - height	1.470 mm
Adjustable speed from / to	From 0 to 40 m/min
Max. surmountable slope (unloaded)	3%
Max. surmountable slope (loaded)	3%
Front wheels	4 x Ø 160 x 60 mm
Wheels material	Polyurethane
Total weight	375 Kg
Electric motor power	0,6 KW / 12V
Hardened battery (standard)	100 Ah / 12 V
Battery charger on board	110 / 240 V -50/60 Hz
Gel battery	•
Proportional control on board of all movements	•
Certification to standard 2006/42 CE	•
Overloading safety system	•
Pressure safety valves on each movements	•
Safety emergency electric devices	•
User Manual and technical documentation	•
Possibility to do all movements with max. Load	•

GB 150

Maximum load capacity	150 kg
Standard min. height from the ground	500 mm
Standard max. height from the ground	2.600 mm
Standard max. telescopic extension	1.500 mm
Capacity at standard max. telescopic extension	150 kg
Wheelbase	1.000 mm
Dimensions - length	1.560 mm
Dimensions - width	820 mm
Dimensions - height	1.470 mm
Adjustable speed from / to	From 0 to 40 m/min
Max. surmountable slope (unloaded)	3%
Max. surmountable slope (loaded)	3%
Front wheels	4 x Ø 160 x 60 mm
Wheels material	Polyurethane
Total weight	525 Kg
Electric motor power	0,6 KW / 12V
Hardened battery (standard)	100 Ah / 12 V
Battery charger on board	110 / 240 V -50/60 Hz
Gel battery	•
Proportional control on board of all movements	•
Certification to standard 2006/42 CE	•
Overloading safety system	•
Pressure safety valves on each movements	•
Safety emergency electric devices	•
User Manual and technical documentation	•
Possibility to do all movements with max. Load	•



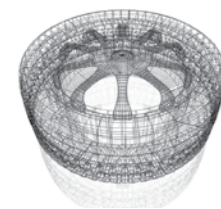

EN GT cranes is the range of mobile cranes chosen by the world's largest manufacturers of tyres and inner tubes: motorcycles, light vehicles, cars, trucks and heavy equipment, earthmoving, civil engineering, aviation.

IT GT cranes è il marchio prescelto dai più grandi produttori mondiali di pneumatici e camera d'aria: motocicli, veicoli leggeri, automobili, autocarro e mezzi pesanti, movimento terra, genio civile, aviazione..

DE GT cranes ist sie die auserwählte Marke der größten Reifen- und Schlauchherstellern weltweit: Motorräder, Leichtfahrzeuge, Autos, Lastwagen und Schwerfahrzeuge, Erdbewegung, Bauwesen, Luftfahrt.

ES GT cranes es la marca escogida por los mayores productores mundiales de neumáticos y cámaras de aire: motocicletas, vehículos ligeros, automóviles, camiones y medios pesados, movimiento de tierras, ingeniería civil, aviación.

FR GT cranes est choisie par les plus grands producteurs mondiaux de pneus et de chambres à air: motocycles, véhicules légers, automobiles, camions et poids-lourds, terrassement, génie civil, aviation.

PT GT cranes é a marca escolhida pelos maiores produtores mundiais de pneus e câmaras de ar: motocicletas, veículos ligeiros, automóveis, caminhões e meios pesados, terraplenagem, engenharia civil, aviação.

GB 300_TR STANDARD

Maximum load capacity	300 kg
Standard min. height from the ground	200 mm
Standard max. height from the ground	3.200 mm
Possibility to extend height up to (option)	-
Standard max. telescopic extension	1.960 mm
Capacity at standard max. telescopic extension	180 kg
Possibility to extend telescopic extension up to (option)	-
Capacity at max.telescopic extension (point 7)	-
Rotation (option)	150°
Wheelbase	1.000 mm
Dimensions - lenght	1.400 mm
Dimensions - width	850 mm
Dimensions - height	1.600 mm
Adjustable speed from / to	From 0 to 40 m/min
Max. surmountable slope (unloaded)	8%
Max. surmountable slope (loaded)	3%
Front wheels	4 x Ø 160 x 60 mm
Rear driving wheel	1 x Ø 160 x 80 mm
Wheels material	Polyurethane
Drive	REAR WHEEL
Total weight	950 Kg
Electric motor power	1,5 KW / 12 V.
Hardened battery (standard)	200 Ah / 12 V
Battery charger on board	110 / 240 V -50/60 Hz
Lead acid battery	-
Gel battery	•
Additional autonomy of battery	○
Proportional control on board of all mouvements	•
Certification to standard 2006/42 CE	•
Made in accordance (not certified) to standard UL508 A	•
Certification (issued by Third Party) to standard UL508 A	○
Drive hydraulic unit	•
Automatic braking system	•
Overloading safety system	•

GB 500_TR STANDARD

Maximum load capacity	500 kg
Standard min. height from the ground	200 mm
Standard max. height from the ground	3.200 mm
Possibility to extend height up to (option)	4.200 mm
Standard max. telescopic extension	1.960 mm
Capacity at standard max. telescopic extension	280 kg
Possibility to extend telescopic extension up to (option)	3.000 mm
Capacity at max.telescopic extension (point 7)	180 kg
Rotation (option)	60° - 150° - 270°
Wheelbase	1.200 mm
Dimensions - lenght	1.550 mm
Dimensions - width	950 mm
Dimensions - height	1.600 mm
Adjustable speed from / to	From 0 to 40 m/min
Max. surmountable slope (unloaded)	8%
Max. surmountable slope (loaded)	3%
Front wheels	4 x Ø 160 x 60 mm
Rear driving wheel	1 x Ø 160 x 80 mm
Wheels material	Polyurethane
Drive	REAR WHEEL
Total weight	1.250 Kg
Electric motor power	1,5 KW / 12 V.
Hardened battery (standard)	200 Ah / 12 V
Battery charger on board	110 / 240 V -50/60 Hz
Lead acid battery	-
Gel battery	•
Additional autonomy of battery	○
Proportional control on board of all mouvements	•
Certification to standard 2006/42 CE	•
Made in accordance (not certified) to standard UL508 A	•
Certification (issued by Third Party) to standard UL508 A	○
Drive hydraulic unit	•
Automatic braking system	•
Overloading safety system	•



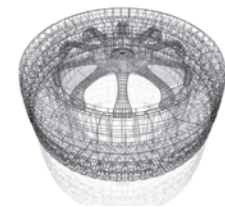

EN GT cranes is the range of mobile cranes chosen by the world's largest manufacturers of tyres and inner tubes: motorcycles, light vehicles, cars, trucks and heavy equipment, earthmoving, civil engineering, aviation.

IT GT cranes è il marchio prescelto dai più grandi produttori mondiali di pneumatici e camera d'aria: motocicli, veicoli leggeri, automobili, autocarro e mezzi pesanti, movimento terra, genio civile, aviazione..

DE GT cranes ist sie die auserwählte Marke der größten Reifen- und Schlauchherstellern weltweit: Motorräder, Leichtfahrzeuge, Autos, Lastwagen und Schwerfahrzeuge, Erdbewegung, Bauwesen, Luftfahrt.

ES GT cranes es la marca escogida por los mayores productores mundiales de neumáticos y cámaras de aire: motocicletas, vehículos ligeros, automóviles, camiones y medios pesados, movimiento de tierras, ingeniería civil, aviación.

FR GT cranes est choisie par les plus grands producteurs mondiaux de pneus et de chambres à air: motocycles, véhicules légers, automobiles, camions et poids-lourds, terrassement, génie civil, aviation.

PT GT cranes é a marca escolhida pelos maiores produtores mundiais de pneus e câmaras de ar: motocicletas, veículos ligeiros, automóveis, caminhões e meios pesados, terraplenagem, engenharia civil, aviação.



MINIDREL 20 SL_AZR

Maximum load capacity	2.000 kg
Standard min. height from the ground	350 mm
Standard max. height from the ground	3.700 mm
Possibility to extend height up to (option)	-
Standard max. telescopic extension	2.500 mm
Capacity at standard max. telescopic extension	625 kg
Possibility to extend telescopic extension up to (option)	-
Capacity at max.telescopic extension (point 7)	-
Rotation (option)	-
Wheelbase	1.500 mm
Dimensions - length	1.860 mm
Dimensions - width	950 mm
Dimensions - height	2.200 mm
Adjustable speed from / to	From 0 to 60 m/min
Max. surmountable slope (unloaded)	8%
Max. surmountable slope (loaded)	3%
Front wheels	2 x Ø 160 x 80 mm
Rear driving wheel	1 x Ø 450 x 110 mm
Wheels material	Polyurethane
Drive	REAR WHEEL
Total weight	3.600 Kg
Electric motor power	3,0 KW / 24 cc.
Hardened battery (standard)	360 Ah / 24 V
Battery charger on board	110 / 240 V -50/60 Hz
Lead acid battery	-
Gel battery	•
Additional autonomy of battery	○
Proportional control on board of all movements	•
Certification to standard 2006/42 CE	•
Made in accordance (not certified) to standard UL508 A	•
Certification (issued by Third Party) to standard UL508 A	○
Drive hydraulic unit	•
Automatic braking system	•
Overloading safety system	•



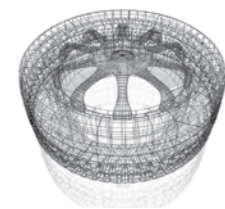

EN GT cranes is the range of mobile cranes chosen by the world's largest manufacturers of tyres and inner tubes: motorcycles, light vehicles, cars, trucks and heavy equipment, earthmoving, civil engineering, aviation.

IT GT cranes è il marchio prescelto dai più grandi produttori mondiali di pneumatici e camera d'aria: motocicli, veicoli leggeri, automobili, autocarro e mezzi pesanti, movimento terra, genio civile, aviazione..

DE GT cranes ist sie die auserwählte Marke der größten Reifen- und Schlauchherstellern weltweit: Motorräder, Leichtfahrzeuge, Autos, Lastwagen und Schwerfahrzeuge, Erdbewegung, Bauwesen, Luftfahrt.

ES GT cranes es la marca escogida por los mayores productores mundiales de neumáticos y cámaras de aire: motocicletas, vehículos ligeros, automóviles, camiones y medios pesados, movimiento de tierras, ingeniería civil, aviación.

FR GT cranes est choisie par les plus grands producteurs mondiaux de pneus et de chambres à air: motocycles, véhicules légers, automobiles, camions et poids-lourds, terrassement, génie civil, aviation.

PT GT cranes é a marca escolhida pelos maiores produtores mundiais de pneus e câmaras de ar: motocicletas, veículos ligeiros, automóveis, caminhões e meios pesados, terraplenagem, engenharia civil, aviação.

MINIDREL 40S_ARR

Maximum load capacity	4.000 kg
Standard min. height from the ground	100 mm
Standard max. height from the ground	3.600 mm
Possibility to extend height up to (option)	-
Standard max. telescopic extension	1.350 mm
Capacity at standard max. telescopic extension	4.000 kg
Possibility to extend telescopic extension up to (option)	2.470 mm
Capacity at max.telescopic extension (point 7)	2.000 kg
Rotation (option)	-
Wheelbase	2.000 mm
Dimensions - length	2.470 mm
Dimensions - width	1.430 mm
Dimensions - height	2.200 mm
Adjustable speed from / to	From 0 to 60 m/min
Max. surmountable slope (unloaded)	8%
Max. surmountable slope (loaded)	3%
Front wheels	2 x Ø300 x 140 mm
Rear driving wheel	1 x Ø 450 x 180 mm
Wheels material	Polyurethane
Drive	REAR WHEEL
Total weight	6.500 Kg
Electric motor power	5,0 KW / 24 cc.
Hardened battery (standard)	420 Ah / 24 V
Battery charger on board	110 / 240 V -50/60 Hz
Lead acid battery	•
Gel battery	○
Additional autonomy of battery	○
Proportional control on board of all mouvements	•
Certification to standard 2006/42 CE	•
Made in accordance (not certified) to standard UL508 A	•
Certification (issued by Third Party) to standard UL508 A	○
Drive hydraulic unit	•
Automatic braking system	•
Overloading safety system	•

MINIDREL 60S_ARR

Maximum load capacity	6.000 kg
Standard min. height from the ground	100 mm
Standard max. height from the ground	3.600 mm
Possibility to extend height up to (option)	-
Standard max. telescopic extension	1.350 mm
Capacity at standard max. telescopic extension	6.000 kg
Possibility to extend telescopic extension up to (option)	2.470 mm
Capacity at max.telescopic extension (point 7)	3.000 kg
Rotation (option)	-
Wheelbase	2.570 mm
Dimensions - length	2.960 mm
Dimensions - width	1.430 mm
Dimensions - height	2.200 mm
Adjustable speed from / to	From 0 to 60 m/min
Max. surmountable slope (unloaded)	8%
Max. surmountable slope (loaded)	3%
Front wheels	2 x Ø300 x 140 mm
Rear driving wheel	1 x Ø 450 x 180 mm
Wheels material	Polyurethane
Drive	REAR WHEEL
Total weight	7.300 Kg
Electric motor power	5,0 KW / 24 cc.
Hardened battery (standard)	420 Ah / 24 V
Battery charger on board	110 / 240 V -50/60 Hz
Lead acid battery	•
Gel battery	○
Additional autonomy of battery	○
Proportional control on board of all mouvements	•
Certification to standard 2006/42 CE	•
Made in accordance (not certified) to standard UL508 A	•
Certification (issued by Third Party) to standard UL508 A	○
Drive hydraulic unit	•
Automatic braking system	•
Overloading safety system	•



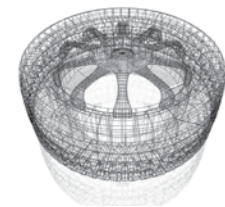

EN GT cranes is the range of mobile cranes chosen by the world's largest manufacturers of tyres and inner tubes: motorcycles, light vehicles, cars, trucks and heavy equipment, earthmoving, civil engineering, aviation.

IT GT cranes è il marchio prescelto dai più grandi produttori mondiali di pneumatici e camera d'aria: motocicli, veicoli leggeri, automobili, autocarro e mezzi pesanti, movimento terra, genio civile, aviazione..

DE GT cranes ist sie die auserwählte Marke der größten Reifen- und Schlauchherstellern weltweit: Motorräder, Leichtfahrzeuge, Autos, Lastwagen und Schwerfahrzeuge, Erdbewegung, Bauwesen, Luftfahrt.

ES GT cranes es la marca escogida por los mayores productores mundiales de neumáticos y cámaras de aire: motocicletas, vehículos ligeros, automóviles, camiones y medios pesados, movimiento de tierras, ingeniería civil, aviación.

FR GT cranes est choisie par les plus grands producteurs mondiaux de pneus et de chambres à air: motocycles, véhicules légers, automobiles, camions et poids-lourds, terrassement, génie civil, aviation.

PT GT cranes é a marca escolhida pelos maiores produtores mundiais de pneus e câmaras de ar: motocicletas, veículos ligeiros, automóveis, caminhões e meios pesados, terraplenagem, engenharia civil, aviação.

MINIDREL 75S_ARR

Maximum load capacity	7.500 kg
Standard min. height from the ground	100 mm
Standard max. height from the ground	3.600 mm
Possibility to extend height up to (option)	-
Standard max. telescopic extension	1.350 mm
Capacity at standard max. telescopic extension	7.500 kg
Possibility to extend telescopic extension up to (option)	3.100 mm
Capacity at max.telescopic extension (point 7)	3.200 kg
Rotation (option)	-
Wheelbase	2.620 mm
Dimensions - lenght	3.250 mm
Dimensions - width	1.490 mm
Dimensions - height	2.200 mm
Adjustable speed from / to	From 0 to 60 m/min
Max. surmountable slope (unloaded)	8%
Max. surmountable slope (loaded)	3%
Front wheels	4 x Ø300 x 140 mm
Rear driving wheel	2 x Ø 450 x 110 mm
Wheels material	Polyurethane
Drive	REAR WHEELS
Total weight	10.300 kg
Electric motor power	8,0 KW / 48 cc.
Hardened battery (standard)	560 Ah / 48V
Battery charger on board	380 /440 V -50/60 Hz
Lead acid battery	●
Gel battery	○
Additional autonomy of battery	○
Proportional control on board of all mouvements	●
Certification to standard 2006/42 CE	●
Made in accordance (not certified) to standard UL508 A	●
Certification (issued by Third Party) to standard UL508 A	○
Drive hydraulic unit	●
Automatic braking system	●
Overloading safety system	●

MINIDREL 100S_ARR

Maximum load capacity	10.000 kg
Standard min. height from the ground	100 mm
Standard max. height from the ground	3.600 mm
Possibility to extend height up to (option)	-
Standard max. telescopic extension	1.350 mm
Capacity at standard max. telescopic extension	10.000 kg
Possibility to extend telescopic extension up to (option)	3.500 mm
Capacity at max.telescopic extension (point 7)	3.700 kg
Rotation (option)	-
Wheelbase	2.920 mm
Dimensions - lenght	3.550 mm
Dimensions - width	1.490 mm
Dimensions - height	2.200 mm
Adjustable speed from / to	From 0 to 60 m/min
Max. surmountable slope (unloaded)	8%
Max. surmountable slope (loaded)	3%
Front wheels	4 x Ø300 x 140 mm
Rear driving wheel	2 x Ø 450 x 110 mm
Wheels material	Polyurethane
Drive	REAR WHEELS
Total weight	11.800 Kg
Electric motor power	8,0 KW / 48 cc.
Hardened battery (standard)	560 Ah / 48V
Battery charger on board	380 /440 V -50/60 Hz
Lead acid battery	●
Gel battery	○
Additional autonomy of battery	○
Proportional control on board of all mouvements	●
Certification to standard 2006/42 CE	●
Made in accordance (not certified) to standard UL508 A	●
Certification (issued by Third Party) to standard UL508 A	○
Drive hydraulic unit	●
Automatic braking system	●
Overloading safety system	●



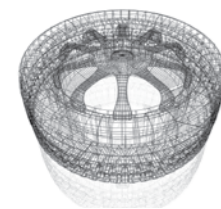

MINIDREL 50B_SRR

Maximum load capacity	5.000 kg
Standard min. height from the ground	0
Standard max. height from the ground	4.800 mm
Possibility to extend height up to (option)	6.000 mm
Standard max. telescopic extension	2.850 mm
Capacity at standard max. telescopic extension	2.000 kg
Possibility to extend telescopic extension up to (option)	3.750 mm
Capacity at max.telescopic extension (point 7)	1.400 kg
Rotation (option)	-
Wheelbase	1.880 mm
Dimensions - lenght	2.750 mm
Dimensions - width	1.350 mm
Dimensions - height	2.660 mm
Adjustable speed from / to	From 0 to 100 m/min
Max. surmountable slope (unloaded)	16%
Max. surmountable slope (loaded)	8%
Front wheels	2 x ø 533 x 178 mm
Rear driving wheel	2 x ø 457x 152 mm
Wheels material	Cushion
Drive	FOUR WHEELS
Total weight	7.400 Kg
Electric motor power	8,0 KW / 48 cc.
Hardened battery (standard)	520 Ah / 48V
Battery charger on board	380 /440 V -50/60 Hz
Lead acid battery	•
Gel battery	○
Additional autonomy of battery	○
Proportional control on board of all mouvements	•
Certification to standard 2006/42 CE	•
Made in accordance (not certified) to standard UL508 A	•
Certification (issued by Third Party) to standard UL508 A	○
Drive hydraulic unit	•
Automatic braking system	•
Overloading safety system	•

MINIDREL 50B_MSR

Maximum load capacity	5.000 kg
Standard min. height from the ground	450 mm
Standard max. height from the ground	5.200 mm
Possibility to extend height up to (option)	-
Standard max. telescopic extension	3.200 mm
Capacity at standard max. telescopic extension	1.500 kg
Possibility to extend telescopic extension up to (option)	4.200 mm
Capacity at max.telescopic extension (point 7)	900 kg
Rotation (option)	-
Wheelbase	2.300 mm
Dimensions - lenght	3.145 mm
Dimensions - width	1.350 mm
Dimensions - height	2.660 mm
Adjustable speed from / to	From 0 to 100 m/min
Max. surmountable slope (unloaded)	16%
Max. surmountable slope (loaded)	8%
Front wheels	2 x ø 533 x 178 mm
Rear driving wheel	2 x ø 457x 152 mm
Wheels material	Cushion
Drive	FOUR WHEELS
Total weight	6.400 Kg
Electric motor power	5,0 KW / 48 cc.
Hardened battery (standard)	460 Ah / 48V
Battery charger on board	380 /440 V -50/60 Hz
Lead acid battery	•
Gel battery	○
Additional autonomy of battery	○
Proportional control on board of all mouvements	•
Certification to standard 2006/42 CE	•
Made in accordance (not certified) to standard UL508 A	•
Certification (issued by Third Party) to standard UL508 A	○
Drive hydraulic unit	•
Automatic braking system	•
Overloading safety system	•

EN

GT cranes is the range of mobile cranes chosen by the world's largest manufacturers of tyres and inner tubes: motorcycles, light vehicles, cars, trucks and heavy equipment, earthmoving, civil engineering, aviation.

IT

GT cranes è il marchio prescelto dai più grandi produttori mondiali di pneumatici e camera d'aria: motocicli, veicoli leggeri, automobili, autocarro e mezzi pesanti, movimento terra, genio civile, aviazione..

DE

GT cranes ist sie die auserwählte Marke der größten Reifen- und Schlauchherstellern weltweit: Motorräder, Leichtfahrzeuge, Autos, Lastwagen und Schwerfahrzeuge, Erdbewegung, Bauwesen, Luftfahrt.

ES

GT cranes es la marca escogida por los mayores productores mundiales de neumáticos y cámaras de aire: motocicletas, vehículos ligeros, automóviles, camiones y medios pesados, movimiento de tierras, ingeniería civil, aviación.

FR

GT cranes est choisie par les plus grands producteurs mondiaux de pneus et de chambres à air: motocycles, véhicules légers, automobiles, camions et poids-lourds, terrassement, génie civil, aviation.

PT

GT cranes é a marca escolhida pelos maiores produtores mundiais de pneus e câmaras de ar: motocicletas, veículos ligeiros, automóveis, caminhões e meios pesados, terraplenagem, engenharia civil, aviação.





SPECIAL LIFTING EQUIPMENT AND IN PARTICULAR FOR LIFTING MOLDS.

EN We can provide an unsurpassable level of technology for all kind of lifting request: customized mobile cranes, truck cranes, ATEX cranes, Ex cranes, compact cranes, lifting robots, aerial platforms, lifting platforms, special forklifts, forklift on demand, trolleys for MBT (main battle tanks), compact cranes for maintenance of helicopters.

IT GT cranes dispone di una vasta gamma di gru elettriche personalizzate su richiesta del cliente e adatte a qualsiasi applicazione: carrelli elevatori per il trasporto di macchinari industriali e militari, gru elettriche per la manutenzione di elicotteri, gru semoventi per l'industria aerospaziale, piattaforme aeree per carichi molto pesanti.

DE Spezielle Hubapparate: ein weiterer Sektor, auf dem Gruniverpal das Maximum an Technologie, Sicherheit und Zuverlässigkeit gewährleistet. Auch bei den schwierigsten Hubmaßnahmen wird der Kunde aller Probleme enthoben.

ES Aparatos de elevación especiales: otro sector en el que Gruniverpal garantiza el máximo en cuanto tecnología, seguridad y fiabilidad. Incluso en las operaciones de elevación más delicadas, el cliente está dispensado de todos los problemas. Grúas móviles personalizadas, grúas ATEX, grúas compactas, robots de elevación, plataformas aéreas, carretillas elevadoras especiales, carretillas a pedido, carros para MBT (tanques de batalla principales), grúas compactas para el mantenimiento de helicópteros.

FR Nous pouvons fournir un niveau de technologie inégalable pour toutes sortes de demandes de levage: mini grues compactes électriques, grues mobiles sur mesure, grues ATEX, grues compactes, engins de levage, nacelles élévatrices, plates-formes élévatrices, chariots élévateurs spéciaux, chariots sur demande, chariots pour MBT (chars de combat principaux), grues compactes pour l'entretien des hélicoptères.

PT Guindastes móveis ideais para segurar cargas difíceis de alcançar. Guindastes elétricos fáceis de manobrar: oferecem a melhor visibilidade, mesmo quando acoplados a cargas volumosas. Aparelhos de elevação especiais: um outro setor em que a Gruniverpal garante o máximo em tecnologia, segurança e fiabilidade. Até nas operações de elevação mais delicadas, o cliente está livre de qualquer problema.



MINIDREL TRC

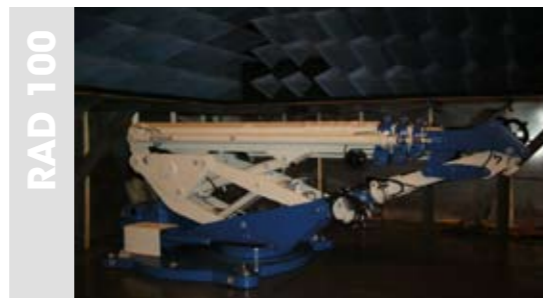

RAD 100



RAD 300



ATEX SERIES



BTS 20000



CS 20



ELIDREL



FORKIDREL



GRUNIROT 20



MANUTIDREL 20



MANUTIDREL 30



MANUTIDREL 100



MINDREL 35SR



PEF 500



PEF 60000



PR 400



TEL 06.700



TEL 12.300



TITAN



CER 200





OPTIONAL FOR MOBILE CRANES AND LIFTING EQUIPMENT.

EN A range of optionals reinforces the concept of 'on demand' in Gt cranes' design and production. Every single detail is viewed as a personalized response to customer needs. Optional for mobile cranes, aerial platforms, ATEX crane, compact cranes, lifting robots, special lifting machines, in particular for lifting moulds.

IT Ampio assortimento di optional e accessori per gru semoventi elettriche Comandi a distanza, Jib idraulici, Carica batterie, argani idraulici, ecc. In GT cranes ogni minimo dettaglio è pensato come risposta personalizzata alle esigenze del cliente. La gamma di optional rafforza il concetto 'on demand' del modo di progettazione e produzione.

DE Große Auswahl an Optionen und Zubehör für elektrische Selbstfahrkrane Die Optionspalette verstärkt noch das "On Demand"-Konzept bei Planung und Produktion von GT cranes. Jedes kleinste Detail ist als eine individuelle Antwort auf die Bedürfnisse des Kunden gedacht.

ES Elevación y equipo de manejo opcional. La gama de extras refuerza el concepto on demand de la forma de proyectar y producir que caracteriza a GT cranes. Cada mínimo detalle está pensado como respuesta personalizada a las exigencias del cliente.

FR La gamme d'options renforce le concept «sur demande» du mode de projet et de la production GT cranes. Le moindre détail est pensé pour apporter une réponse personnalisée aux exigences du client.

PT A gama de acessórios reforça o conceito "on demand" do modo de concepção e produção GT cranes. Cada detalhe é pensado como resposta personalizada às exigências do cliente.





CRANES OPTIONAL

SPECIAL TABLES



PROXIMITY SENSORS



RECLINING FORKS



REMOVABLE HELM



NO MARKS WHEELS



CRANES OPTIONAL

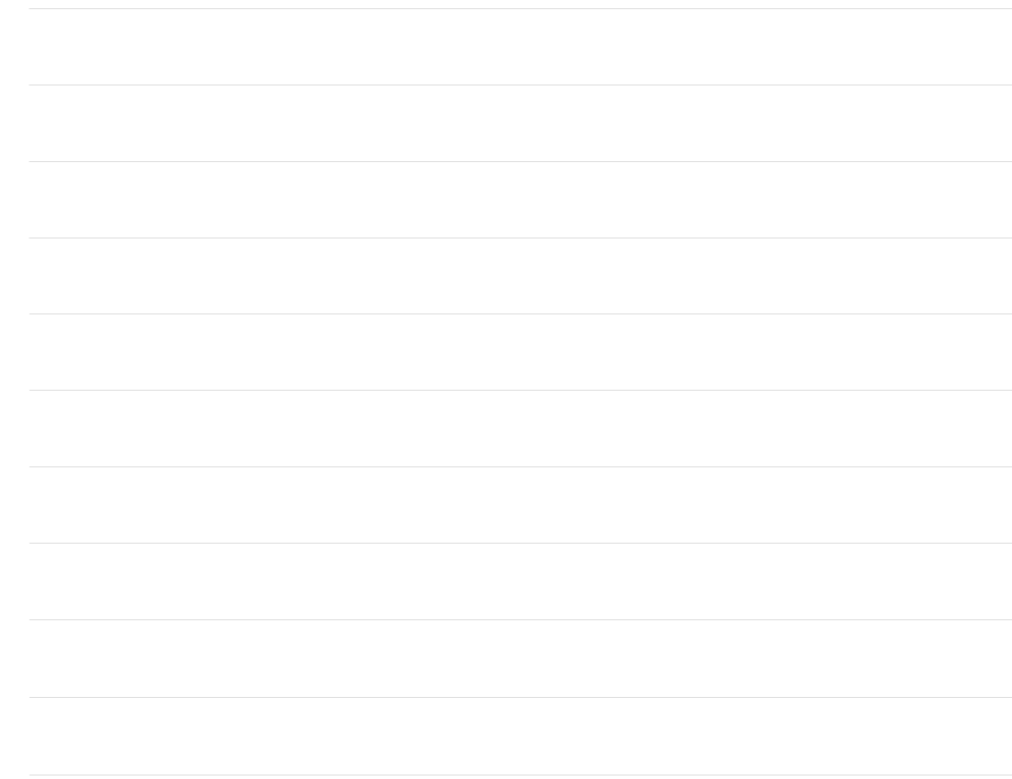

NOTES

